

Nikon

En

Autofocus Speedlight

SB-600



User's Manual





SB-600 (En)

For your safety

Before using your product, please read the following safety precautions carefully and thoroughly to ensure correct and safe use and to help prevent damage to your Nikon product or injury to yourself or others. For quick reference by those who use the product, please keep these safety instructions near the product.

In this manual, safety instructions are indicated with these symbols:

 **WARNING** Disregarding instructions marked with this symbol could result in personal injury, or death and property damage.

 **CAUTION** Disregarding instructions marked with this symbol could result in property damage.

Symbol for separate collection applicable in European countries



This symbol indicates that this product is to be collected separately. The following apply only to users in European countries.

- This product is designated for separate collection at an appropriate collection point. Do not dispose of as household waste
- For more information, contact the retailer or the local authorities in charge of waste management.

WARNINGS for Speedlights

- 1 If corrosive liquids seep from the batteries and get in your eyes, immediately wash your eyes with running water and consult with a doctor.** Your eyes could be seriously damaged if they are not treated quickly.
- 2 If corrosive liquids seep from the batteries and come in contact with your skin or clothes, wash immediately with running water.** Prolonged contact could injure your skin.
- 3 Never attempt to disassemble or repair the flash unit by yourself,** as this could result in you receiving an electric shock and could also cause the unit to malfunction; such malfunction could lead to personal injury.
- 4 If the flash unit is dropped and damaged, do not touch any exposed interior metal parts.** Such parts, especially the speedlight's capacitor and associated parts, could be in a high-charge state and if touched could cause an electric shock. Disconnect the power or remove the batteries and be sure that you do not touch any of the product's electrical components, and then bring the flash unit to your local Nikon dealer or authorized service center for repair.
- 5 If you detect heat, smoke or notice a burning smell, immediately stop operation and remove the batteries** to prevent the unit from catching on fire or melting. Allow the flash unit to cool down so that you can safely touch it and remove the batteries. Then bring the unit to your local Nikon dealer or authorized service center for repair.
- 6 The flash unit should never be submerged in liquid or exposed to rain, saltwater or moisture unless it is properly protected from the liquids and moisture. Underwater use requires a certified underwater housing.** If water or moisture gets inside the unit, this could cause the unit to catch on fire or cause an electric shock. In such instances you should immediately remove the batteries from the speedlight and then bring the unit to your local Nikon dealer or authorized service center for repair.
Note: electronic devices that are penetrated by water or moisture are often not economically repairable.
- 7 Do not use the unit in the presence of flammable or explosive gas.** If the flash unit is operated in areas where there is a flammable gas, including propane, gasoline and dust, it could cause an explosion or fire.
- 8 Do not fire the flash unit directly at the driver of a moving car,** as this could temporarily impair the driver's vision and cause an accident.
- 9 Do not fire the flash unit directly into the eyes of someone that is at close range,** as it could damage their eyes' retinas. Never fire the flash unit closer than 1 meter from infants.

For your safety

- 10 Do not fire the unit while the flash head is touching a person or object.** Such use can result in the person being burned, and/or their clothes igniting from the heat of the flash's firing.
- 11 Keep small accessories out of the reach of children** to avoid the possibility of the accessory being swallowed. If an accessory is accidentally swallowed, immediately consult with a doctor.
- 12 Use only the batteries specified in this user's manual.** Batteries other than those specified could leak corrosive liquids, explode or catch on fire or otherwise not perform satisfactorily.
- 13 Do not mix battery types, brands or old and new batteries,** as the batteries could leak corrosive liquids, explode or catch on fire. When using more than one battery in a product, always use identical batteries that were purchased at the same time.
- 14 Non-rechargeable batteries such as manganese, alkaline-manganese and lithium batteries should never be charged in a battery charger** because they could leak corrosive liquids, explode or catch on fire.
- 15 When using standard size (AA, AAA, C, D) or other common rechargeable batteries such as NiCd and Ni-MH battery types, or when recharging them, be sure to use only the battery charger specified by the battery maker and read the instructions thoroughly. Do not recharge these batteries with their terminals reversed in the charger or before the batteries have cooled off sufficiently** because they could leak corrosive liquids, explode or catch on fire. The same caution also applies to using the rechargeable batteries that may be supplied by the photo product's manufacturer.



CAUTIONS for Speedlights

- 1 Do not touch the flash unit with wet hands,** as this could cause an electric shock.
- 2 Keep the flash unit away from children to prevent them from putting the unit in or near their mouth, or otherwise touching a dangerous part of the product;** as such contact could cause an electric shock.
- 3 Do not apply strong physical shocks to the unit,** as this could cause a malfunction that could cause the unit to explode or catch on fire.
- 4 Never use active agents that contain flammable substances such as paint thinner, benzene or paint remover to clean the unit, and never store the unit in locations containing chemicals such as camphor and naphthalene,** as this could damage the plastic case, cause a fire or cause an electric shock.

- 5 Remove any batteries from the unit before storing the unit for a long time** to prevent the unit from catching on fire or leaking corrosive liquids.

WARNINGS for Batteries

- 1 Never heat or throw batteries into a fire**, as this could cause the batteries to leak corrosive liquids, generate heat or explode.
- 2 Do not short-circuit or disassemble the batteries** because this could cause the batteries to leak corrosive liquids, generate heat or explode.
- 3 Do not mix battery types, brands or old and new batteries**, as this could cause the batteries to leak corrosive liquids, generate heat or explode.
- 4 Do not install batteries in the reverse direction as this could cause the batteries to leak corrosive liquids, generate heat or explode. Even if only one battery is installed in reverse it will cause the speedlight to malfunction.**
- 5 Be sure to use the battery charger specified by the battery maker** to avoid the possibility of batteries leaking corrosive liquids, generating heat or exploding.
- 6 Do not carry or store batteries along with metallic materials such as necklaces and hair pins** because such materials could cause the batteries to short-circuit, leading to battery leakage, heat generation or an explosion. **In addition, specially when carrying a quantity of batteries, place them carefully in a storage case that prevents the battery terminals from touching another battery's terminals** because if they touch in reverse order it could also cause the batteries to short-circuit, leading to battery leakage, heat generation or an explosion.
- 7 If corrosive liquids seep from the batteries and get in your eyes, immediately wash your eyes with running water and consult with a doctor.** Your eyes could be seriously damaged if they are not treated quickly.
- 8 If corrosive liquids seep from the batteries and come in contact with your skin or clothes, wash immediately with running water.** Prolonged contact could injure your skin.
- 9 Always follow the warnings and instructions printed on the batteries** to avoid activities that could cause the batteries to leak corrosive liquids, generate heat or catch on fire.
- 10 Be sure to use only batteries specified in this user's manual**, to avoid the possibility of batteries leaking corrosive liquids, generating heat or exploding.

For your safety

- 11 Never open the casing surrounding batteries or use batteries whose casing has been breached** as such batteries could leak corrosive liquids, generate heat or explode.
- 12 Keep batteries out of the reach of children** to help avoid the possibility of them being swallowed. If a battery is accidentally swallowed, immediately consult with a doctor.
- 13 Batteries should not be submerged in water, exposed to rain, moisture or saltwater unless they are properly protected from the wet environment.** If water or moisture gets inside the batteries, this could cause them to leak corrosive liquids or generate heat.
- 14 Do not use any battery that appears abnormal in any way, including a change in color or shape.** Such batteries could leak corrosive liquids or generate heat.
- 15 Stop recharging rechargeable batteries if you notice that recharging is not completed within the specified time** to help prevent the possibility of the battery leaking corrosive liquids or generating heat.
- 16 When recycling or disposing of batteries, be sure to insulate their terminals with tape.** If the battery's positive and negative terminals short-circuit after coming into contact with metallic objects, it could cause fire, heat generation or an explosion. Dispose of used batteries in accordance with local government regulations.
- 17 Non-rechargeable batteries should never be charged in a battery charger** because they could leak corrosive liquids or generate heat.
- 18 Remove dead batteries from your equipment immediately,** as they could leak corrosive liquids, generate heat or explode.



CAUTION for Batteries

Do not throw or apply strong physical shocks to the batteries as this could cause batteries to leak corrosive liquids, generate heat or explode.

Contents

Preparation

- For your safetyi-v
- Foreword4-6
- Tips on using the Speedlight7
- Camera groups and available flash modes8-9
- Speedlight parts and their functions10-11
- Control buttons12

Easy setting for the optimum TTL auto flash mode13

- LCD panel14-15
- Lenses16

• Basic operation17

- 1 Installing the batteries18-19
 - 2 Test firing (Confirming the exposure)20-21
 - 3 Attach the SB-600 to the camera and adjust
the flash head22-23
 - 4 Setting the camera's exposure mode and
metering system24-25
 - 5 Setting the SB-600's flash mode26-27
 - 6 Compose the picture and shoot with flash28-29
- Using the SB-600 with the COOLPIX30

• Detailed operation31

- SB-600's available flash modes32
- TTL auto flash mode33
- Manual mode34-37
- Notes on continuous flash shooting38

• Other functions39

- Setting the zoom-head position40-41
- Exposure compensation and flash output-level
compensation42-44

· Checking the illumination before actually taking the picture (Modeling illuminator).....	45
· Slow-sync flash mode, red-eye reduction control, and rear-curtain sync	46-47
· Auto FP High-Speed Sync mode (for compatible cameras).....	48-49
· Flash Value Lock (FV Lock) (for compatible cameras).....	50
· Autofocus flash operation in dim light	51-52
· Custom Settings.....	53-55
• Advanced operations.....	57
· Overview of multiple flash operation	58-59
· Wireless multiple flash shooting	60-61
· Flash shooting in Advanced Wireless Lighting	62-66
· Confirming wireless multiple flash operation using the ready-light or the beeping sound.....	67
· Multiple flash shooting using cords.....	68-69
· System chart for TTL multiple flash shooting using cords.....	70-71
· Bounce flash operation.....	72-74
· Close-up flash operation.....	75-77
Flash shooting in the 1/300 TTL High-Speed Flash sync mode (F5 only)	78
• Reference information	79
· TTL auto flash modes available with the SB-600	80-82
· Optional accessories	83-84
· Tips on Speedlight care.....	85
· Notes on handling batteries.....	86
· Troubleshooting.....	87-88
· Specifications.....	89-91
· Index	92-93

Preparation

This section provides preliminary information on using the SB-600.

Basic operation

Basic procedures to take simple, properly exposed flash photographs in the TTL auto flash mode.

Detailed operation

A variety of flash modes available with the SB-600 are explained.

Other functions

Detailed information on each function of the SB-600 is provided.

Advanced operations

Information on advanced flash shooting techniques using the SB-600 is described.

Reference information

Optional accessories, Troubleshooting, Speedlight care, Specifications, etc. are presented in this section.

Thank you for purchasing the Nikon Speedlight SB-600. To get the most out of your Speedlight, please read this user's manual thoroughly before use. Also, read the separate booklet, "A collection of example photos," which provides an overview of the SB-600's flash-shooting capabilities with example photos. In addition, keep your camera user's manual handy for quick reference.

●● Main features and functions of the SB-600

- The SB-600 is a high-performance Speedlight with a guide number of 30/98 (ISO 100, m/ft.) or 42/138 (ISO 200, m/ft.) (at the 35mm zoom-head position, 20°C/68°F.) According to the camera and lens combination used with the SB-600, you can perform various types of TTL auto flash (p. 33) and Manual flash operations (p. 34).
- A power zoom function automatically adjusts the zoom-head position to match the lens focal length (with the exception of some camera/lens combinations) (p. 40). When the built-in wide-flash adapter is used, the zoom-head position is automatically set to match a 14mm lens (p. 41).
- The flash head can be tilted from 0° to 90° and rotated horizontally 180° to the left and 90° to the right, enabling bounce flash (p. 72) or close-up flash photography (p. 75).
- In wireless multiple flash photography, the SB-600 can be used as a wireless remote flash unit when the SB-600 is used with cameras compatible with the Nikon Creative Lighting System (p. 5).
- When using bounce flash or taking close-ups with flash, you can use the built-in wide-flash adapter to create soft, diffused lighting with virtually no shadows, while maintaining balanced lighting for the main subject and the background (pp. 72, 75).
- Custom settings are provided to set values, or activate or cancel functions that are unnecessary to set each time (p. 53).

Nikon Creative Lighting System

The SB-600 features the Nikon Creative Lighting System (**CLS**). This system offers additional flash shooting possibilities with digital cameras by taking advantage of a camera's digital communication capabilities. CLS is available only when the SB-600 is used with compatible Nikon cameras. The SB-600 offers these major features:

- **i-TTL mode**

This is a TTL auto flash mode in the Nikon Creative Lighting System. Monitor Preflashes are fired at all times. The subject is correctly exposed by the light from the flash lighting and the exposure is less affected by the ambient light (p. 32).

- **Advanced Wireless Lighting**

With Advanced Wireless Lighting, wireless multiple flash operation in the TTL (i-TTL) mode can now be accomplished with digital SLRs. In this mode, you can divide the remote flash units into three groups and control the flash output independently for each group, expanding your range of creative multiple-flash shooting techniques. The SB-600 can be used only as a wireless remote flash unit (p. 62).

- **Flash Value Lock**

Flash Value (FV) is the amount of flash exposure needed for a subject. Using FV Lock with compatible cameras, you can lock in the appropriate flash exposure for the main subject. This flash exposure will remain fixed, even if you change the aperture or composition, or zoom the lens in or out (p. 50).

- **Flash Color Information Communication**

When the SB-600 is used with compatible digital SLRs, color temperature information is automatically transmitted to the camera. In this way, the camera's white balance is automatically adjusted to give you the correct color temperature when taking photographs with the SB-600.

- **Auto FP High-Speed Sync**

High-Speed flash synchronization at your camera's highest shutter speed is now possible. This is useful when you want to use a wider aperture to achieve shallow depth of field to blur the background (p. 48).

- **Wide-Area AF-Assist Illuminator**



In autofocus operation, the SB-600 emits AF-Assist illumination over a wider area. This enables you to perform autofocus photography in dim light even after you change the focus area of cameras supporting this function (p. 51).

See your equivalent camera's user's manual for details on the Nikon Creative Lighting System.

Notes

- **Default:** Functions and flash modes preset when shipped from the factory are referred to as “Default” settings in this manual.
- **CLS:** Hereafter, Nikon’s new Speedlight system “Nikon **C**reative **L**ighting **S**ystem” is abbreviated “**CLS**.”

Marks used in this manual

- : Denotes important points to prevent malfunction or shooting failure.
- : Useful points that should be remembered for better usage of the SB-600.
- : Provides convenient reference information when using the SB-600.

Supplied accessories



Speedlight Stand
AS-19

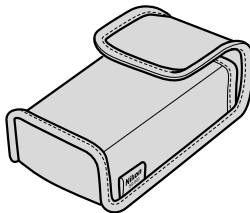

Soft Case
SS-600

Tips on using the Speedlight

Take trial shots

Take trial shots before photographing important occasions like weddings or graduations.

Have Nikon spot-check your Speedlight regularly

Nikon recommends that you have your Speedlight serviced by an authorized dealer or service center at least once every two years.

Using your Speedlight correctly

The Nikon Speedlight SB-600's performance has been optimized for use with Nikon brand cameras/accessories, including lenses.

Camera/accessories made by other manufacturers may not meet Nikon's criteria for specifications, and nonconforming cameras/accessories could damage the SB-600's components. Nikon cannot guarantee the SB-600's performance when used with non-Nikon products.

Life-long learning

As part of Nikon's "Life-long learning" commitment to ongoing product support and education, continually updated information is available on-line at the following sites:

- For users in the U.S.A.: <http://www.nikonusa.com/>
- For users in Europe: <http://www.europe-nikon.com/support>
- For users in Asia, Oceania, the Middle East, and Africa: <http://www.nikon-asia.com/>

Visit these sites to keep up to date with the latest product information, tips, answers to frequently asked questions (FAQs), and general advice on digital imaging and photography. Additional information is available from the Nikon representative in your area. See the URL below for contact information:

<http://nikonimaging.com/>

Notes:

- *The Nikon N90s, N90, N75-Series, N70, N60, N55-Series, N50, N8008, N8008s, Pronea 6i, N6006, N6000, N5005, N4004s and N4004 are sold exclusively in the U.S.A.*
- *The Nikon N80-Series, N65-Series are sold exclusively in the U.S.A. and Central and South America.*
- *The Nikon N2020 and N2000 are sold exclusively in the U.S.A and Canada.*

Camera groups and available flash modes

In this manual, Nikon cameras are divided into 10 groups, including cameras compatible with CLS*, digital SLRs not compatible with CLS*, and cameras in Groups I to VII, unless otherwise noted. First, consult the camera group table to see which group your camera belongs to. Then as you read the manual, you will find specific information on how to use the SB-600 with your particular camera.

* CLS: Nikon Creative Lighting System (p. 5)

Group	Camera name
Cameras compatible with CLS*	D3-Series, D700, D2-Series, D300-Series, D200, D90, D80, D70-Series, D5000, D3000, D60, D50, D40-Series, F6
Digital SLRs not compatible with CLS*	D1-Series, D100
I	F5, F100, F90X/N90s, F90-Series/N90, F80-Series/N80-Series, F75-Series/N75-Series, F70-Series/N70
II	F4-Series, F65-Series/N65-Series, F-801s/N8008s, F-801/N8008, Pronea 600i/6i
III	F-601/N6006, F-601M/N6000
IV	F60-Series/N60, F50-Series/N50, F-401x/N5005
V	F-501/N2020, F-401s/N4004s, F-401/N4004, F-301/N2000
VI	FM3A, FA, FE2, Nikonos V, F3-Series (with the AS-17)
VII	New FM2, FM10, FE10, F3-Series, F55-Series/N55-Series
COOLPIX cameras compatible with i-TTL	COOLPIX 8800, COOLPIX 8400, COOLPIX P5100, COOLPIX P5000
	COOLPIX P6000

*1 **BL**: Balanced Fill-Flash. This always appears together with **III** (p. 33).

*2 Wireless multiple flash in the i-TTL mode is possible. (Works as a remote flash unit only.) (p. 62)

*3 While performing Balanced Fill-Flash, no **BL** indicator appears.

*4 Some functions are not possible. For details, see p. 66.

The SB-600's available flash modes vary, depending on the cameras and lenses in use or the camera's exposure mode and metering system. For more details, refer to "Detailed operation" (p. 31), "TTL auto flash modes available with the SB-600" (p. 80) and your camera's user's manual.

○: Available
 –: Not available

	TTL auto flash mode (p. 33)				M Manual mode (p. 34)	Wireless multiple flash
	TTL i-TTL	TTL D-TTL	TTL TTL	BL *1		Advanced Wireless Lighting (works as a remote flash unit only) (p. 62)
	○	–	–	○	○	○*2
	–	○	–	○	○	–
	–	–	○	○	○	–
	–	–	○	○	○	–
	–	–	○	○*3	○	–
	–	–	○	○*3	○	–
	–	–	○	–	○	–
	–	–	○	–	○	–
	–	–	–	–	○	–
	○	–	–	–	○	–
	○	–	–	–	○	○*4

Speedlight parts and their functions

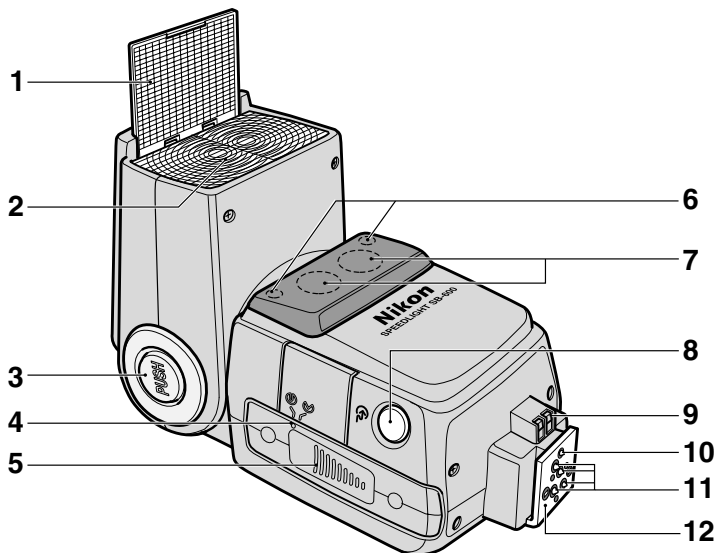

1 Built-in wide-flash adapter (p. 76)

Increases the angle of coverage to match a 14 mm lens.

2 Flash head (p. 74)

Can be tilted from 0° to 90° and rotated horizontally 180° to the left and 90° to the right.

3 Flash head tilting/rotating lock-release button (p. 22)

4 Battery chamber lid open-close index (p. 18)

5 Battery chamber lid (p. 18)

6 Auxiliary ready-light (p. 67)

Works as a ready-light when the SB-600 is used as a wireless remote flash unit.

7 Wide-area AF-assist illuminator (p. 51)

Automatically turns on for autofocus operation when the light is dim.

8 Light sensor window for wireless remote flash (p. 60)

9 External AF-assist illuminator contacts

Accepts optional TTL Remote Cord SC-29

10 Mount pin

11 Hot-shoe contacts

12 Mounting foot

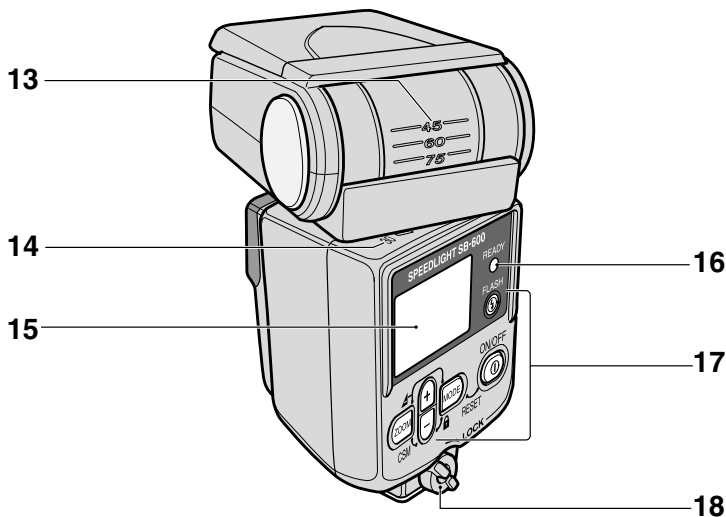
**13 Flash head tilting-angle scale**

(p. 74)

14 Flash head rotating-angle scale

(p. 74)

15 LCD panel (p. 14)**16 Ready-light**

Lights up when the SB-600 is fully recycled and ready to fire. Blinks after the SB-600 fires at its maximum output in the TTL auto flash mode, indicating that the light may be insufficient.

17 Control buttons (p. 12)**18 Mounting-foot lock lever** (p. 22)

Control buttons

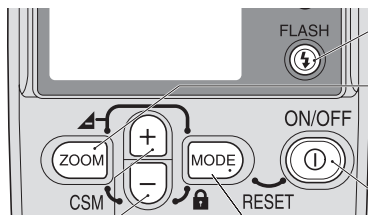

FLASH button

Press to test fire the flash (p. 20).

ZOOM button

Press to change the zoom-head position (p. 40).

- Press to adjust the settings in the Custom Settings mode (p. 53).

ON/OFF button

Press for approx. 0.3 second to turn the power on or off.

+ button/- button

Press to increase or decrease the values.

- Press to choose the desired settings in the Custom Settings mode (p. 53).
- Press to adjust the settings when setting the remote flash unit (p. 63).

MODE button

Press to set the flash mode (p. 26).

- Press to adjust the settings in the Custom Settings mode (p. 53).
- Press to choose the desired settings when setting the remote flash unit (p. 63).

Two-button control function

Press two buttons simultaneously to perform the following operations.

Follow the procedures shown on the flash unit.

	<p>Recalling the underexposure value in the TTL auto flash mode</p> <p>Press the ZOOM and MODE buttons simultaneously to recall the underexposure value (p. 29).</p>
	<p>Resetting the settings to default values</p> <p>Press the MODE and ON/OFF buttons simultaneously for approx. 2 seconds to reset all settings, including the custom settings, to their default settings.</p>
	<p>Button lock</p> <p>Press the MODE and +/- buttons simultaneously for approx. 1 second to lock the functions of the control buttons (except the ON/OFF and FLASH buttons) to avoid accidental malfunction. Press the buttons again to release the lock.</p>
	<p>Switching to Custom Settings</p> <p>Press the ZOOM and +/- buttons simultaneously for approx. 2 seconds to enter the Custom Settings mode (p. 53).</p>

Easy setting for the optimum TTL auto flash mode



Press the **MODE** and **ⓘ** buttons simultaneously for approx. 2 seconds to reset all settings, including the custom settings, to their default settings.

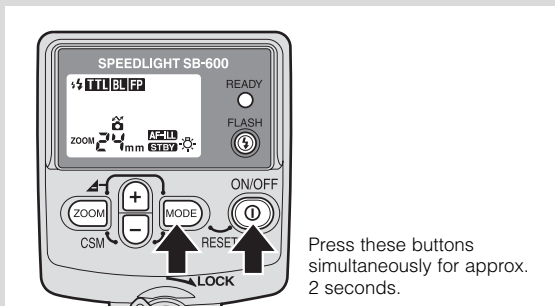

While the SB-600 is used with cameras compatible with CLS, digital SLRs not compatible with CLS and cameras in Groups I to II in combination with a CPU lens, the optimum TTL auto flash mode available with that combination will be performed when you set the camera's exposure mode to Programmed Auto (P), and turn on the SB-600 to execute "Resetting the settings to default values."

LCD panel

For reference, all indications are displayed in the illustration.

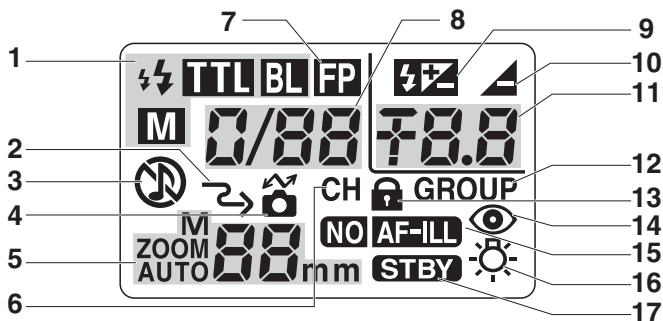

- 1 Flash mode** (p. 26)
- 2 Wireless remote flash** (p. 62)
In the wireless multiple flash mode, the SB-600 is set as a remote flash unit, which fires in sync with the master flash unit.
- 3 Sound monitor** (p. 67)
When the SB-600 is set as a remote flash unit, you can monitor its operation by listening to the beeping sound.
- 4 Compatible with CLS*** (p. 5)
The SB-600 is connected to cameras compatible with CLS*.
- 5 Zoom-head position** (p. 40)
- 6 Channel** (p. 63)
Represents the communication channel number through which the master and remote flash units exchange data in the Advanced Wireless Lighting mode.
- 7 Auto FP High-Speed Sync** (p. 48)
The SB-600 automatically fires at faster shutter speeds exceeding the camera's sync shutter speed.
- 8 Flash output level** (p. 34)
- 9 Flash output-level compensation** (p. 44)
- 10 Underexposure in TTL auto flash** (p. 29)
- 11 Flash output-level compensation value** (p. 44)
Underexposure value in TTL auto flash (p. 29)
Indicates the underexposure value, showing that the light might be insufficient in the TTL auto flash mode.
- 12 Group** (p. 63)
Represents the group of each remote flash unit in the Advanced Wireless Lighting mode.
- 13 Control buttons being locked** (p. 12)
Control buttons (except the ON/OFF and FLASH buttons) are locked.
- 14 Red-eye reduction** (p. 46)
- 15 AF assist illuminator** (p. 51)
- 16 LCD panel illuminator** (p. 15)
Pressing any control button turns on the LCD panel illuminator.
- 17 Standby function** (p. 21)

☐☐ Characteristics of the LCD panel

- Due to the directional characteristics of LCDs, the display is difficult to read when viewed from above. However, the display can be seen clearly from a slightly lower angle.
- The LCD display becomes darker at high temperatures (approx. 60°C/140°F), but returns to normal at normal temperatures (20°C/68°F).
- The LCD's response time decreases at low temperatures (approx. 5°C/41°F and below), but returns to normal at normal temperatures (20°C/68°F).

☑ Using the SB-600 in dim light

Press any button on the SB-600 to turn the illuminator on (when the SB-600 power is on), and it will remain lit for 16 seconds.

- To cancel the LCD panel illumination, go to the Custom Settings mode (p. 53) and set it to OFF.
- Even if the LCD panel illuminator is set to OFF, the SB-600's LCD panel illuminator turns on when the camera's LCD panel illuminator is turned on. The LCD panel illuminator also lights up when the Custom Settings mode is displayed.

Lenses

In this manual, Nikkor lenses are divided into two types: CPU Nikkor lenses and non-CPU Nikkor lenses.

CPU Nikkor lenses	G-type Nikkor, D-type Nikkor, Non-G/D-type AF Nikkor (except for AF Nikkor for the F3AF), AI-P Nikkor
Non-CPU Nikkor lenses	AI-S Nikkor, AI Nikkor, Series E, etc.

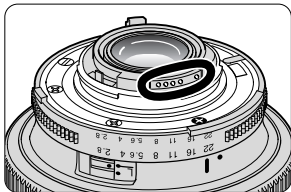

CPU lenses

CPU lenses have CPU contacts.

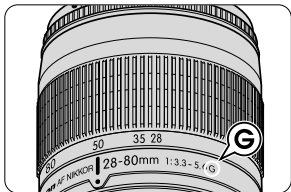

G-type Nikkor lenses

G-type Nikkor lenses send distance information to the camera body, but do not have an aperture ring. Therefore, set the aperture on the camera body. With some cameras, the usable exposure mode is limited. For more details, refer to the lens user's manual.

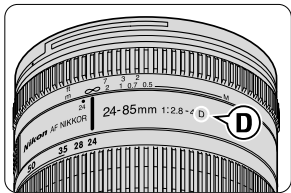

D-type Nikkor lenses

D-type Nikkor lenses send distance information to the camera body. Set the aperture either on the lens aperture ring or on the camera body. For more details, refer to the lens user's manual.

Basic operation

In this section, basic procedures are illustrated so that you can easily perform flash photography in the TTL auto flash mode. You can easily perform flash photography by following Steps 1-6 on the left-hand pages.

The procedures are based on the use of a CPU lens mounted on cameras compatible with CLS*, digital SLRs not compatible with CLS*, and cameras in Groups I to II. The SB-600's functions and the LCD display vary depending on the camera/lens combination used.

* CLS: Nikon Creative Lighting System (p. 5)

1 Installing the batteries

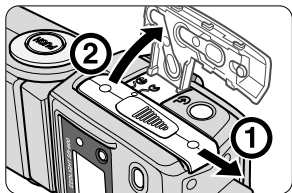

- 1** Slide the battery chamber lid in the direction of the arrow to open.

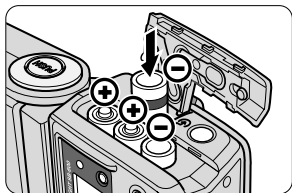

- 2** Install the batteries following the ⊕ and ⊖ marks as shown. Close the battery chamber lid by sliding it into place while pressing down.

✔ Usable batteries

Install four AA-type penlight batteries (1.5 V or lower) of any of these types:

- (1) Alkaline-manganese (1.5 V) (2) Lithium (1.5 V) (3) Nickel (1.5 V)
(4) NiCd (rechargeable, 1.2 V)
(5) Ni-MH (Nickel Metal Hydride) (rechargeable, 1.2 V)

- When replacing batteries, replace all four with fresh ones of the same brand.
- Carbon-zinc batteries are not recommended for use with the SB-600.
- Always carry extra batteries when travelling.
- For details on batteries, refer to "Notes on handling batteries" (p. 86).

CAUTION!

- Do not use batteries not specified in this user's manual, as this may cause them to explode, leak corrosive liquids or catch on fire.
- Do not mix battery brands or types, or use old with new batteries, as they might explode, leak corrosive liquids or catch on fire.
- Do not place non-rechargeable batteries in a battery charger, as this might cause them to leak corrosive liquids or generate heat.

Minimum number of flashes and recycling times

The following data are based on a situation in which four fresh batteries of the same type are used and the Speedlight fires at M1/1 output.

Batteries	Min. recycling time (approx.)*	Min. number of flashes/recycling time*
Alkaline-manganese	3.5 sec.	200/3.5-30 sec.
Lithium	4.0 sec.	400/4.0-30 sec.
Nickel	2.5 sec.	180/2.5-30 sec.
NiCd (1000 mAh) (rechargeable)	2.9 sec.	90/2.9-30 sec.
Ni-MH (2000 mA) (rechargeable)	2.5 sec.	220/2.5-30 sec.

* With fresh batteries

- These data were measured without using the wide-area AF-assist illuminator, zoom-head position adjustment or LCD panel illumination.
- The above data may vary due to variations in battery performance.

Replacing/recharging the batteries

Refer to the following table to determine when to replace or recharge your batteries, if the ready-light takes a long time to come on.

Type of battery	Recycling time	Remedy
Alkaline-manganese	More than 30 seconds	Replace
Lithium	More than 10 seconds	
Nickel	More than 10 seconds	
NiCd (rechargeable)	More than 10 seconds	Recharge
Ni-MH (rechargeable)		

2 Test firing (Confirming the exposure)

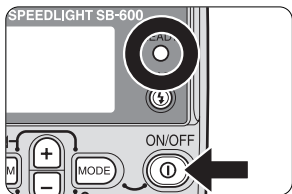

- 1 Press the  button for approx. 0.3 second to turn on the SB-600. Make sure the ready-light comes on.

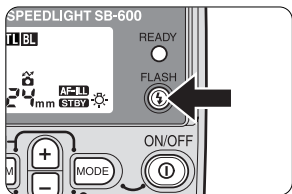

- 2 Press the  button to test fire the flash.

Test firing

CAUTION!

Do not test fire the Speedlight near your eyes.

- The SB-600 fires at specified output in the Manual flash mode or at approx. 1/16 output in the TTL auto flash mode.

button

Pressing the  button for approx. 0.3 second turns on the SB-600 and the indications appear on the LCD panel. Pressing the button again turns off the SB-600 and the indications disappear.

Standby function to conserve battery power

If the SB-600 and camera are not being used, the standby function will automatically activate after 40 seconds, switching the SB-600 to standby mode to conserve battery power.

- In the standby mode, the **STBY** indicator appears on the LCD panel.
- When used with a camera body that is compatible with the TTL auto flash mode (p. 8), the SB-600 will automatically turn off after the camera's exposure meter is switched off.
- When in standby mode, the SB-600 turns back on again when its **(1)** or **(2)** button is pressed or the shutter release button is lightly pressed (when using a camera body that is compatible with the TTL auto flash mode) (p. 8).
- The standby function does not work in the wireless flash mode, regardless of the SB-600's setting, when the Speedlight is used as a remote flash unit (p. 59).
- If, due to battery exhaustion, the ready-light does not come on within 60 seconds of turning on the power or after the flash has fired, the following indicator appears on the LCD panel and the SB-600 enters standby mode regardless of its setting. In this case, replace or recharge your batteries.



- To avoid accidental firing or a malfunction when carrying the SB-600 in your camera bag, press the **(1)** button to turn off the flash unit, and make sure the **STBY** indicator disappears.

Setting the standby function

Set the standby function in the Custom Settings mode (p. 53).

3 Attach the SB-600 to the camera and adjust

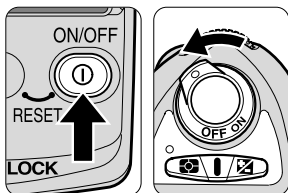

- 1** Make sure the SB-600 and camera body are turned off.

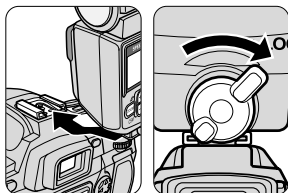

- 2** Rotate the mounting-foot lock lever to the left, slide the SB-600's mounting foot into the camera's accessory shoe and turn the lock lever to the right.

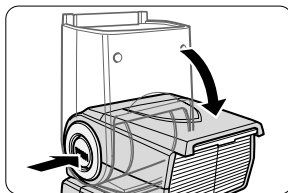

- 3** Hold down the flash head tilting/rotating lock-release button to adjust the flash head to the horizontal/front position.

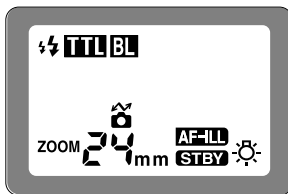

- 4** Turn on the SB-600 and the camera body.
- The zoom-head position is automatically adjusted according to the lens focal length when the SB-600 is used with cameras compatible with CLS, digital SLRs not compatible with CLS, cameras in Groups I to II in combination with a CPU lens, and COOLPIX cameras compatible with i-TTL.
 - When the SB-600 is used with cameras other than those listed above, or you want to adjust the zoom-head position manually, refer to "Setting the zoom-head position" (p. 40).

the flash head.

☑ Turn the mounting-foot lock lever securely until it stops.

To lock the Speedlight in place, turn the lock lever approx. 90° clockwise until it stops. To unlock, turn the lever counter-clockwise until it stops.

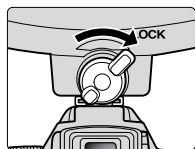

Lock

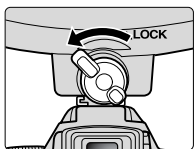

Unlock

☑ Digital data communication with the SB-600

Digital data communication is performed when the SB-600 is used with cameras compatible with CLS, digital SLRs not compatible with CLS and cameras in Groups I to II. With a CPU lens, data such as focal length are automatically transferred to the SB-600.



4 Setting the camera's exposure mode and

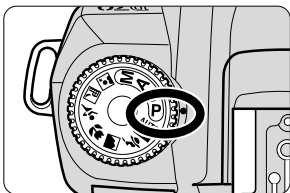

1 Set the camera's exposure mode to Programmed Auto (P).

- If Programmed Auto (P) cannot be set, select another exposure mode. See the opposite page.

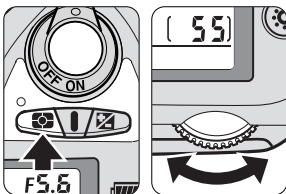

2 Set the camera's metering system to Matrix Metering.

- If Matrix Metering cannot be set, select Center-Weighted Metering.

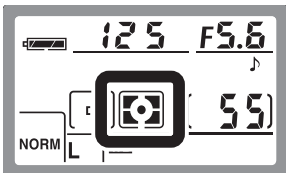

Exposure mode and metering system

The camera's available exposure mode and metering system vary, depending on the cameras and lenses in use or the SB-600's flash modes. For details, refer to "Detailed operation" (p. 31), "TTL auto flash modes available with the SB-600" (p. 80) and your camera's user's manual.

- In the Programmed Auto (P) mode, the shutter speed is automatically set to the camera's sync shutter speed.

☑ Exposure modes other than Programmed Auto exposure (P)

In Shutter-Priority Auto exposure (S) mode

By selecting a slower shutter speed, the proper exposure for the background can be achieved.

- The camera selects the correct aperture. For details, see your camera's user's manual. However, set the shutter speed on the camera after confirming that the automatically controlled aperture will provide an appropriate shooting distance range for your subject. Refer to "Flash shooting distance range in the TTL auto flash mode" (p. 27).
- If you set a shutter speed faster than the flash sync speed, the camera automatically shifts to its fastest sync speed when the SB-600 is turned on (except in the Auto FP High-Speed sync mode) (p. 48).

In Aperture-Priority Auto exposure (A) mode

By selecting the aperture, you can control depth of field and the flash shooting distance range.

- The camera selects the correct shutter speed. For details, see your camera's user's manual.
- To determine the aperture, refer to the "Guide number" (p. 35) and "Flash shooting distance range in the TTL auto flash mode" (p. 27).

In Manual exposure (M) mode

By selecting the shutter speed and aperture, you can control the exposure of the background, the depth of field and the flash shooting distance range.

- If you set a shutter speed faster than the flash sync speed, the camera automatically shifts to its fastest sync speed when the SB-600 is turned on. This is true of all cameras, except mechanical shutter cameras and when using the Auto FP High-Speed sync mode (p. 48).
- To determine the aperture, refer to "Guide number" (p. 35) and "Flash shooting distance range in the TTL auto flash mode" (p. 27).

5 Setting the SB-600's flash mode

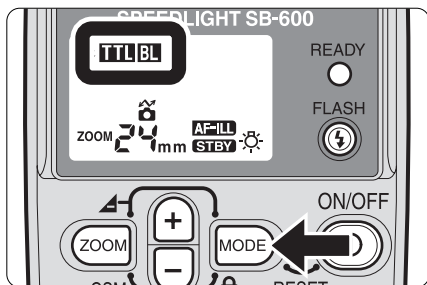

- 1 Press the **MODE** button to set the flash mode.
 - Display **TTL BL** on the LCD panel.

Selecting the flash mode

The available flash mode changes each time the **MODE** button is pressed.

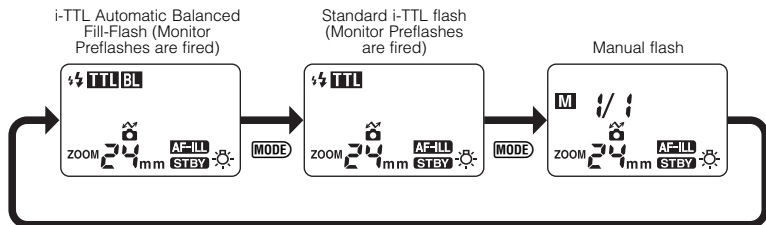

- The information above appears on the LCD panel when the SB-600 is used with digital SLR cameras compatible with CLS.
- Note that when pressing the **MODE** button, only the usable flash modes appear; unavailable modes will be skipped.
- The SB-600's available flash modes vary, depending on the cameras and lenses in use or the camera's exposure mode and metering system. Refer to "Detailed operation" (p. 31), "TTL auto flash modes available with the SB-600" (p. 80) and your camera's user's manual.

●● About the flash shooting distance range

The SB-600's flash shooting distance range is 0.6 m to 20 m (2 to 66 ft.) and varies, depending on the ISO sensitivity, zoom-head position and lens aperture in use.

Flash shooting distance range in the TTL auto flash mode

Aperture	ISO sensitivity							Zoom-head position (mm)						
	1600	800	400	200	100	50	25	14*1	24	28	35	50	70	85
*2														
2.8	2	1.4												
4	2.8	2	1.4											
5.6	4	2.8	2	1.4				0.9-9.8/ 3.0-32	1.5-16/ 4.9-52	1.6-17/ 5.2-56	1.8-19/ 5.9-62	2.0-20/ 3.3-66	2.3-20/ 7.5-66	2.5-20/ 8.2-66
8	5.6	4	2.8	2	1.4			0.7-7.0/ 2.3-23	1.1-11/ 3.6-36	1.2-12/ 3.9-39	1.3-14/ 4.3-46	1.5-16/ 4.9-52	1.6-18/ 5.2-59	1.8-20/ 5.9-66
11	8	5.6	4	2.8	2	1.4		0.6-4.9/ 2.0-16	0.8-8.1/ 2.6-27	0.8-8.8/ 2.6-29	0.9-9.8/ 3.0-32	1.0-11/ 3.3-36	1.2-12/ 3.9-39	1.2-14/ 3.9-44
16*3	11	8	5.6	4	2.8	2		0.6-3.5/ 2.0-11	0.6-5.7/ 2.0-19	0.6-6.2/ 2.0-20	0.7-7.0/ 2.3-23	0.8-8.0/ 2.6-26	0.8-9.0/ 2.6-30	0.9-10/ 2.9-33
22	16	11	8	5.6	4	2.8		0.6-2.4/ 2.0-7.9	0.6-4.0/ 2.0-13	0.6-4.4/ 2.0-14	0.6-4.9/ 2.0-16	0.6-5.6/ 2.0-18	0.6-6.3/ 2.0-21	0.7-7.0/ 2.3-23
32	22	16	11	8	5.6	4		0.6-1.7/ 2.0-5.6	0.6-2.8/ 2.0-9.2	0.6-3.1/ 2.0-10	0.6-3.5/ 2.0-11	0.6-4.0/ 2.0-13	0.6-4.5/ 2.0-15	0.6-5.0/ 2.0-16
	32	22	16	11	8	5.6		0.6-1.2/ 2.0-3.9	0.6-2.0/ 2.0-6.6	0.6-2.2/ 2.0-7.2	0.6-2.4/ 2.0-7.9	0.6-2.8/ 2.0-9.2	0.6-3.1/ 2.0-10	0.6-3.5/ 2.0-11
		32	22	16	11	8		0.6-0.8/ 2.0-2.6	0.6-1.4/ 2.0-4.6	0.6-1.5/ 2.0-4.9	0.6-1.7/ 2.0-5.6	0.6-2.0/ 2.0-6.6	0.6-2.2/ 2.0-7.2	0.6-2.5/ 2.0-8.2
			32	22	16	11		-	0.6-1.0/ 2.0-3.3	0.6-1.1/ 2.0-3.6	0.6-1.2/ 2.0-3.9	0.6-1.4/ 2.0-4.6	0.6-1.5/ 2.0-4.9	0.6-1.7/ 2.0-5.6
				32	22	16		-	0.6-0.7/ 2.0-2.3	0.6-0.7/ 2.0-2.3	0.6-0.8/ 2.0-2.6	0.6-1.0/ 2.6-3.3	0.6-1.1/ 2.0-3.6	0.6-1.2/ 2.6-3.9

Flash shooting distance range (m/ft.)

*1 With the wide-flash adapter in place

*2 TTL auto flash operation is not possible at this ISO sensitivity. For ISO 1000, use an aperture 2/3 of an f/stop smaller than the aperture for ISO 1600, or 1/3 larger than the aperture for ISO 800.

*3 ■ Programmed TTL Auto Flash with the F-501/N2020, F-401s/N4004s, F-401/N4004, and F-301/N2000. (ISO 25 to ISO 400 for the F-401s/N4004s and F-401/N4004)

🔧 ISO sensitivity

The sensitivity of digital SLRs and the film speed for film-based cameras are referred to as ISO sensitivity in this manual.

6 Compose the picture and shoot with flash



- 1 Confirm the camera's sync mode.
 - For normal flash photography, use the camera's front-curtain sync mode.

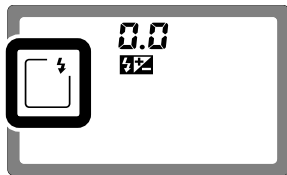

- 2 Compose the picture, confirm that the ready-light on the SB-600 or in the camera's viewfinder is on, then shoot.

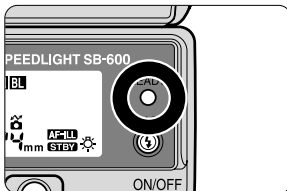

Set the camera's flash sync mode to front-curtain sync.

With cameras featuring a rear-curtain sync flash mode, make sure the camera's flash sync mode is set to front-curtain sync.

- For other flash sync modes, refer to "Slow-sync flash" (p. 46), "Red-eye reduction with slow-sync flash mode" (p. 46), or "Rear-curtain sync" (p. 47).
- Refer to the camera's user's manual for details on the flash sync mode.

☑ **If the ready-light blinks after shooting, the light might be insufficient for correct exposure.**

When the flash has fired at its maximum output in the TTL auto flash mode and underexposure possibly occurred, the ready-lights on the SB-600 and in the camera's viewfinder blink for approx. 3 seconds. Depending on the camera in use, the ready-light on the SB-600 or in the camera's viewfinder lights up. To compensate, use a wider aperture after setting the camera's exposure mode to Aperture-Priority Auto (A) or Manual (M), or move closer to the subject and reshoot.

Display of the amount of underexposure

The amount of underexposure (0 to -3.0 EV) appears for approx. 3 seconds on the SB-600's LCD panel when used with cameras compatible with CLS, digital SLRs not compatible with CLS, cameras in Group I and COOLPIX cameras compatible with i-TTL in the TTL auto flash mode. The above ready-lights will also blink at the same time.

- Pressing the **ZOOM** and **MODE** buttons simultaneously recalls this display.

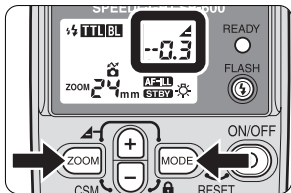

Using the SB-600 with the COOLPIX



For COOLPIX cameras, such as the COOLPIX 8800 and 4500, that **have an accessory shoe (hot-shoe) or TTL multiple flash terminal**: When more powerful illumination is required or when performing multiple flash, it is recommended to connect the SB-600 or another Nikon Speedlight compatible with TTL auto flash to the COOLPIX. Auto flash operation is possible by setting the SB-600's flash mode to TTL auto flash. The flash output level is controlled by detecting signals from the camera to determine when to start and stop firing. This is controlled by Standard i-TTL flash operation with COOLPIX cameras compatible with i-TTL and by Non-TTL operation with other COOLPIX cameras.

- For connection to COOLPIX cameras with hot-shoe contacts, such as the COOLPIX 8800, attach the Speedlight directly to the accessory shoe.
- Optional accessories such as the Multi-Flash Bracket Unit SK-E900 should be used for connection with COOLPIX cameras that have a TTL multiple flash terminal but no hot-shoe contacts.
- For details, see your camera's user's manual.

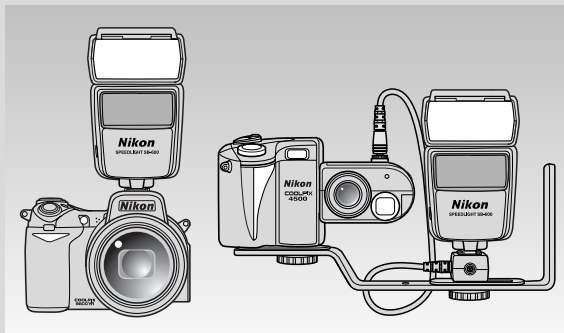

Please note that wireless multiple flash using the COOLPIX's built-in flash as a master flash unit and the SB-600 as a remote flash unit cannot be performed.

Detailed operation

This section provides a variety of flash modes available with the SB-600. Be sure to refer to your camera's user's manual for specific information on camera settings and functions.

SB-600's available flash modes



The SB-600's available flash modes vary, depending on the cameras and lenses in use or the camera's exposure mode. Using the TTL auto flash mode is recommended for normal flash photography.

Available flash modes and usable cameras

Available flash mode		Usable cameras
TTL auto flash mode	i-TTL mode	Cameras compatible with CLS, COOLPIX cameras compatible with i-TTL
	D-TTL mode	Digital SLRs not compatible with CLS
	TTL (film-based) mode	Cameras (film-based) in Groups I to VI (No  appears with cameras in Groups III and IV while performing Balanced Fill-Flash)
Manual mode	Manual flash	No limitation

Monitor Preflashes

The SB-600 fires a series of imperceptible Monitor Preflashes just before the flash fires so that the camera can obtain necessary information on the subject. This applies to situations when the SB-600 is used with cameras compatible with CLS, digital SLRs not compatible with CLS, cameras in Group I with a CPU lens, and COOLPIX cameras compatible with i-TTL, and flash mode is set to TTL auto flash.

- Monitor Preflashes are fired instantaneously and cannot be differentiated from the main flash.
- When Monitor Preflashes are fired,  appears on the LCD panel (when using a single flash unit). For cameras in Group I, however, Monitor Preflashes are not fired when the SB-600's flash head is adjusted to other than the horizontal/front position or the camera's flash sync mode is set to rear-curtain sync, even when  appears on the LCD panel.

TTL auto flash mode

●● TTL auto flash mode: **TTL**

In this mode, the flash illumination that is reflected back from the subject is detected by the camera's TTL auto flash sensor and the camera automatically controls the flash output level to give the correct exposure.

Automatic Balanced Fill-Flash: **TTL BL**

Press the **MODE** button to display **TTL BL** on the LCD panel, and Automatic Balanced Fill-Flash is performed. The flash output level is automatically adjusted for a well-balanced exposure of the main subject and background. When performing Balanced Fill-Flash, however, no **BL** appears with cameras in Groups III and IV.

- **TTL BL** indicates "i-TTL Automatic Balanced Fill-Flash" in the i-TTL mode.

Standard TTL flash: **TTL**

Press the **MODE** button to display **TTL** on the LCD panel, and Standard TTL flash is performed. The main subject is correctly exposed regardless of the background brightness. This is useful when you want to highlight the main subject.

- **TTL** indicates "Standard i-TTL flash" in the i-TTL mode, "Standard TTL flash for Digital SLRs" in the D-TTL mode, and "Standard TTL flash" in the TTL (film-based) mode.

🔪 Notes on TTL mode indicators

Comparison tables are provided on pages 80-82 to show the SB-600's TTL mode indicators and the corresponding ones used in the user's manuals of Speedlights featuring no CLS.

- For details on shooting procedures in the TTL auto flash mode, refer to "Basic operation" (p. 17).

Manual mode

Manual mode

In Manual flash photography, you select the aperture and flash output level. This allows you to control the exposure and flash shooting distance when the correct exposure is difficult to obtain in the TTL auto flash mode. The flash output level can be set from M1/1 (full output) to M1/64 to suit your creative preferences.

You can calculate the correct aperture by using the guide number table and the shooting distance. Then, set the same aperture manually on the lens. In this case, set the camera's exposure mode to Aperture-Priority Auto (**A**) or Manual (**M**).

- No limitation on usable cameras.
- Refer to your camera's user's manual for details on camera and lens aperture settings.
- The shutter might not be released if the camera's exposure mode is at a setting other than Aperture-Priority (**A**) or Manual (**M**) and the SB-600 is in Manual mode, depending on the camera in use. For details, refer to your camera's user's manual.
- In the Manual mode, there is no warning ready-light to indicate that the light may have been insufficient to obtain a correct exposure.

●● LCD panel in the Manual mode

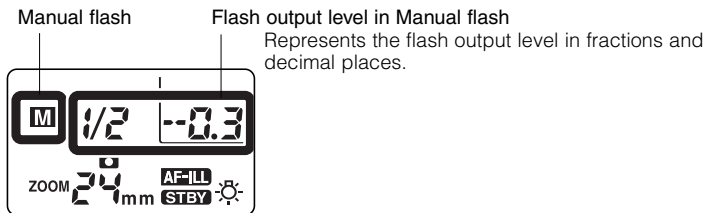

LCD panel when a camera compatible with CLS is used.

●● Determining the aperture, flash output level and shooting distance in the Manual mode

In the Manual mode, use the guide number table and the following equation to calculate the aperture, flash output level and shooting distance to obtain the correct exposure.

- The guide number (GN at ISO 100; m/ft) indicates the amount of light generated by the flash. The larger the number, the greater the flash output.

Guide number (ISO 100, m/ft)

Flash output level	Zoom-head position (mm)						
	14*	24	28	35	50	70	85
M1/1	14.0/45.9	26.0/85.3	28.0/91.9	30.0/98.4	36.0/118.1	38.0/124.7	40.0/131.2
M1/2	9.9/32.5	18.4/60.4	19.8/65.0	21.2/69.6	25.5/83.7	26.9/88.3	28.3/92.8
M1/4	7.0/23.0	13.0/42.7	14.0/45.9	15.0/49.2	18.0/59.1	19.0/62.3	20.0/65.6
M1/8	4.9/16.1	9.2/30.2	9.9/32.5	10.6/34.8	12.7/41.7	13.4/44.0	14.1/46.3
M1/16	3.5/11.5	6.5/21.3	7.0/23.0	7.5/24.6	9.0/29.5	9.5/31.2	10.0/32.8
M1/32	2.5/8.2	4.6/15.1	4.9/16.1	5.3/17.4	6.4/21.0	6.7/22.0	7.1/23.3
M1/64	1.8/5.9	3.3/10.8	3.5/11.5	3.8/12.5	4.5/14.8	4.8/15.7	5.0/16.4

* With the wide-flash adapter in place

ISO sensitivity factors

For sensitivities other than ISO 100, multiply the guide number by the factors shown in the table below.

ISO	25	50	100	200	400	800	1600
Factors	x0.5	x0.71	x1	x1.4	x2	x2.8	x4

To calculate the correct aperture

Calculate the correct aperture by using this equation and the guide number table, according to the ISO sensitivity, shooting distance, flash output level and zoom-head position that are set:

$$f/\text{stop (aperture)} = \text{Guide number (GN at ISO 100; m/ft.)} \times \text{ISO sensitivity factor} \div \text{Shooting distance (m/ft.)}$$

For example, for the ISO sensitivity of 400 (or ISO sensitivity factor: 2), with the zoom-head position adjusted to 28mm, and the flash output level set to M1/1:

- Referring to the guide number table, determine the guide number as 28/91.9 (m/ft.).

When the shooting distance is 3.5m (11.5 ft.), the correct aperture value is:

$$28/91.9 \text{ (GN at ISO 100, m/ft.)} \times 2 \text{ (ISO sensitivity factor for ISO 400)} \div 3.5/11.5 \text{ (shooting distance; m/ft.)} = 16 \text{ (aperture)}$$

- Set the aperture value 16 on both the SB-600 and the camera or lens.

To obtain the correct flash output level

Calculate the guide number (GN at ISO 100; m/ft.) by using this equation, according to the shooting distance and aperture required.

$$\text{Guide number (GN at ISO 100; m/ft.)} = \text{Shooting distance (m/ft.)} \times \text{Aperture (f)} \div \text{ISO sensitivity factor}$$

Referring to the guide number table, determine an appropriate flash output level corresponding to the guide number obtained above, then set the same value on the SB-600.

For example, for the ISO sensitivity of 400 (or ISO sensitivity factor: 2) and the shooting distance of 3.5m (11.5 ft) with an aperture of f/8:

$$3.5/11.5 \text{ (shooting distance; m/ft.)} \times 8 \text{ (aperture value)} \div 2 \text{ (ISO sensitivity factor of ISO 400)} = 14/45.9 \text{ (GN at ISO 100; m/ft.)}$$

Manual mode

- When the zoom-head position is adjusted to 28mm, set M1/4 flash output level on the SB-600, which can be obtained from GN 14/45.9 (m/ft.) corresponding to the zoom-head position of 28mm referring to the guide number table.
- In Distance-priority manual flash operation, the correct flash output level is automatically determined by the SB-600 according to the shooting distance, aperture and ISO sensitivity that are set.

To calculate the shooting distance

Calculate the shooting distance (m/ft.) by using this equation and the guide number table, according to the ISO sensitivity, aperture value, flash output level and zoom-head position that are set:

$$\text{Shooting distance (m/ft.)} = \text{Guide number (GN at ISO 100; m/ft.)} \times \text{ISO sensitivity factor} \div \text{Aperture (f)}$$

Manual **M** flash operation

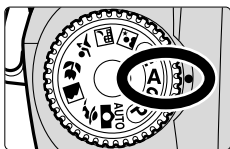

- 1** Set the camera's exposure mode to Aperture-Priority Auto (**A**) or Manual (**M**).

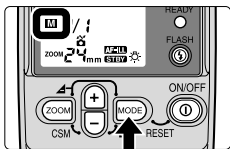

- 2** Press the **MODE** button until **M** appears on the LCD panel.

- 3** Determine the flash output level and aperture to match the flash shooting distance.

- For details on determining the flash output level and the aperture, refer to "Determining the aperture and flash output level in the Manual mode" (p. 35).

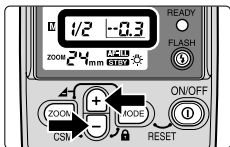

- 4** Press the \oplus or \ominus button to increase or decrease the values.

- Refer to "Setting the flash output level" (p. 37).

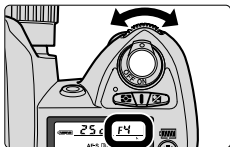

- 5** Set the aperture on your camera or lens.

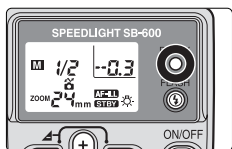

6 Confirm that the ready-light comes on, then shoot.

Setting the flash output level

The flash output level changes every time you press the \ominus or \oplus button, as shown below.

When you press the \ominus button:

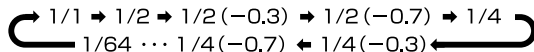

When you press the \oplus button:

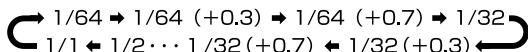

- The numbers in parentheses represent the adjustable flash output level in $\pm 1/3$ step except between 1/1 and 1/2. Therefore, 1/2 (-0.7) and 1/4 (+0.3) represent the same flash output level.

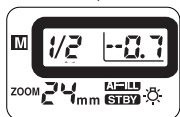

=
The same flash
output level

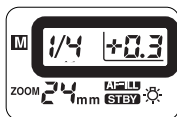

- To extend the flash shooting distance, choose a flash output level close to M1/1.
- The value can be quickly changed by continuously pressing the \oplus or \ominus button.
- The decimal place blinks during adjustment.

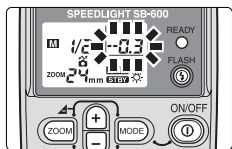

Notes on continuous flash shooting



WARNING

Do not exceed the maximum number of continuous firings

You should allow the SB-600 to cool off for at least 10 minutes after the maximum number of continuous firings are performed as shown in the table below:

Max. number of continuous firings

Flash mode	Max. number of continuous firings (at 6 frames/sec.)
TTL auto flash	15
Manual flash (Flash output level: M1/1, M1/2)	
Manual flash (Flash output level: M1/4 to M1/64)	40

●● Synchronization during continuous flash shooting

The table below shows the maximum number of frames that can be taken during continuous flash shooting. If the number of continuous frames shot exceeds the value shown in the table, allow the SB-600 to cool off for at least 10 minutes.

Maximum number of frames during continuous flash shooting (at six frames per sec.)

Batteries	Flash output level			
	1/8	1/16	1/32	1/64
Alkaline-manganese	Up to 4	Up to 8	Up to 16	Up to 30
Lithium				
Nickel				
NiCd				
Ni-MH				

Other functions

Detailed information on each function of the SB-600 is provided.

Setting the zoom-head position

The zoom-head position is automatically adjusted by the power zoom function. It can also be manually adjusted.

- The guide number indicating flash output level varies according to the zoom-head position (p. 35).

☐ The power zoom function

When the SB-600 is used with cameras compatible with CLS, digital SLRs not compatible with CLS, and cameras in Groups I to II in combination with a CPU lens, the power zoom function activates and the zoom head is automatically adjusted.

- The zoom-head position is automatically adjusted to match focal lengths of 24mm, 28mm, 35mm, 50mm, 70mm and 85mm when the power zoom function is activated.
- When the lens focal length is not one of those indicated above, the zoom head adjusts to the closest wide-angle setting of the lens in use. For example, if the zoom setting of a CPU lens was between 36mm and 49mm, the zoom-head position would be adjusted to 35mm.
- If a small **M** does not appear above the “ZOOM” indication on the LCD panel, the zoom-head position will be automatically adjusted. If a small **M** appears, keep pressing the **ZOOM** button until it disappears.

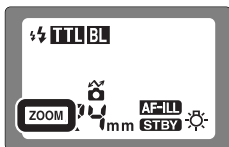

Power zoom activated

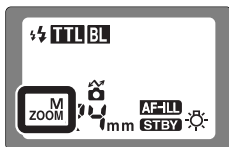

Power zoom canceled

☑ When the SB-600 is used with COOLPIX cameras compatible with i-TTL

The zoom-head position is automatically adjusted by the power zoom function. “AUTO” appears below the “ZOOM” indicator on the LCD panel.

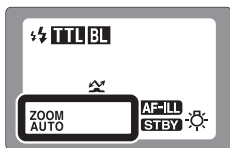

Indications when a COOLPIX camera compatible with i-TTL is used.

☛ Setting the zoom-head position manually

When the SB-600 is used with cameras in Groups III to VII in combination with a non-CPU lens, or you want to change the zoom-head position to one that does not match the focal length, you should adjust the zoom-head position manually by pressing the **(ZOOM)** button.

- A small **M** above the "ZOOM" indication appears on the LCD panel while manually setting the zoom-head position.
- Every time you press the **(ZOOM)** button, the zoom-head position changes as follows:

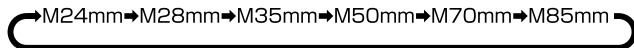

- When the camera/lens combination is compatible with the power zoom function, the zoom-head position changes as follows when a 35mm lens is attached:

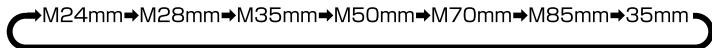

- As a general rule, set the zoom-head position to the focal length of the lens in use or to the closest wide-angle setting. For example, select the 50mm setting when using a 60mm lens.

☛ Canceling the power zoom function using Custom Settings

The power zoom function can be canceled in the Custom Settings mode (p. 53). When the power zoom function is canceled, the zoom head can be manually adjusted, but the zoom-head position indicator does not change even if the lens is zoomed, a lens is changed or the ON/OFF button is pressed.

- When the power zoom function is canceled, a small **M** always blinks on the LCD panel.
- Every time you press the **(ZOOM)** button, the zoom-head position changes as follows:

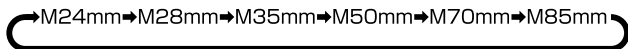
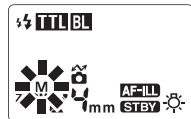

☛ Using the built-in wide-flash adapter

Use the built-in wide-flash adapter when a 14mm to 23mm lens is mounted (p. 76).

- When using the wide-flash adapter, the zoom-head position is automatically set to 14mm and the power zoom function is deactivated.
- When using a 14mm or 17mm lens, the distance between the camera and subject generally differs greatly from the center of the frame to the periphery, so the peripheral area might not be sufficiently lit in some cases.

Exposure compensation and flash output-level

Exposure compensation allows you to take well-balanced pictures by intentionally modifying the flash exposure. This is useful when a subject of extremely high or low reflectivity is included in the scene or when you want to create flash photographs to match your creative preferences.

- Some plus compensation may be necessary when the background includes a mirror, white wall or other highly reflective surface. Likewise, some minus compensation may be required when the background is dark or includes subjects of low reflectivity.
- Making exposure compensation for both the main subject and background, the main subject only without affecting the background, or the background only without affecting the main subject is possible, depending on the flash shooting situation.

Exposure compensation on the SB-600 can be performed in these ways:

Exposure compensation	Available flash mode	Usable camera
Making exposure compensation for both the main subject and background	All flash modes	Cameras in all groups
Making exposure compensation for the main subject only	TTL auto flash mode	Cameras compatible with CLS, digital SLRs not compatible with CLS, cameras in Groups I to III, and COOLPIX cameras compatible with i-TTL.
	Manual flash mode	Cameras in all groups
Making exposure compensation for the background only	Flash shooting at slow shutter speeds	Cameras in all groups

●● Making exposure compensation for both the main subject and background

In the TTL auto flash mode

Use the camera's exposure compensation function to modify both the SB-600's flash output level and the background exposure. For details, see your camera's user's manual.

- The exposure compensation value set on the camera is not displayed on the SB-600's LCD panel.
- Exposure compensation beyond the usable ISO sensitivity range cannot be performed. For example, even if you tried to make an exposure compensation of +3 steps when using an ISO sensitivity of 100, which would change it to the equivalent of ISO 12, you would only be able to compensate a maximum of +2 steps (ISO 25) because the usable sensitivity range is ISO 25-1000.

Making exposure compensation in the Manual flash mode

Exposure compensation is performed by intentionally modifying the correct aperture.

- Use the guide number and shooting distance to calculate which aperture to use for the correct exposure (p. 35). Then, use a larger or smaller aperture on the camera to make exposure compensation.
- As a basic guide, set a wider aperture on the camera or lens to make the main subject brighter or a smaller aperture to make it darker.

☹☹ Making exposure compensation for the main subject only

In the TTL auto flash mode

Adjusting the SB-600's flash output level to shoot a flash-illuminated main subject without affecting the background exposure is known as flash output-level compensation (p. 44).

- This compensation can only be performed with cameras compatible with CLS, digital SLRs not compatible with CLS, cameras in Groups I to III, and COOLPIX cameras compatible with i-TTL.

In the Manual flash mode

Making exposure compensation for only the flash-illuminated subject by intentionally modifying the SB-600's flash output level (M1/1 to M1/64).

- For cameras in all groups

☹☹ Making exposure compensation for the background only

Set the camera's exposure mode to Shutter-Priority Auto (**S**) or Manual (**M**), and set the shutter speed to one slower than its flash sync shutter speed.

- With cameras providing slow-sync, set the camera's flash sync mode to Slow-sync (p. 46) to bring out background details in low-light situations.
- For details, see your camera's user's manual.



Exposure compensation and flash output-level compensation

Flash output-level compensation

You can make exposure compensation for the flash-illuminated subject without affecting the background exposure by modifying the SB-600's flash output level.

- Available in the TTL auto flash mode.
- Flash output level compensation is only available with cameras compatible with CLS, digital SLRs not compatible with CLS, cameras in Groups I to III, and COOLPIX cameras compatible with i-TTL.
- With F-601/N6006 and F-601M/N6000 cameras, make flash output-level compensation on the camera. Flash output-level compensation cannot be made on the SB-600. The amount of compensation set on the camera does not appear on the SB-600's LCD panel. For details, see your camera user's manual.
- With SLR cameras that have a built-in Speedlight with an exposure compensation function, you can compensate the flash output level on either the camera or the SB-600. For details, see your camera user's manual. If you use both controls, the exposure is modified by the sum total of both compensation values. In this case, the SB-600's LCD panel shows only the compensation value set on the SB-600.

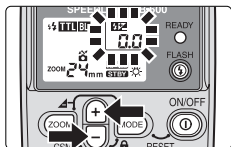

- 1 Press the \oplus or \ominus button to display the flash output-level compensation. The flash output-level compensation value blinks.

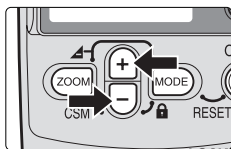

- 2 Press the \oplus or \ominus button to increase or decrease the compensation in 1/3 steps from -3.0 to $+3.0$ EV.
 - The value can be quickly changed by continuously pressing the \oplus or \ominus button.

Canceling flash output-level compensation

The flash output-level compensation cannot be canceled by turning the SB-600 off. To cancel, press the \oplus or \ominus button to return the compensation value to "0.0".

Checking the illumination before actually taking the picture (Modeling illuminator)

When using the Modeling illuminator function, the flash fires repeatedly at a reduced flash output level. This is useful for checking the illumination and the shadows cast on the subject before actually taking the picture.

- The Modeling illuminator function operates for 1 second.
- This function operates only after the ready-light comes on.

●● Modeling illuminator with cameras compatible with CLS attached

The Modeling illuminator fires when the Modeling illuminator button on a compatible camera is pressed.

- For details, see your camera user's manual.



Slow-sync flash mode, red-eye reduction control,

☼☼ Slow-sync flash

The flash is controlled at a slow shutter speed to obtain the correct exposure for both the main subject and background in low-light situations or at night.

- Available with cameras that have a slow-sync function. The slow-sync function cannot be set on the SB-600; it can only be set on the camera. For more information, refer to your camera user's manual.
- As slow shutter speeds are normally used for slow sync, a tripod is recommended to prevent camera shake.

☼☼ Red-eye reduction

To prevent the center of your subject's eyes from appearing red in color pictures, the SB-600 fires three flashes at reduced output just before the picture is taken.

- Available with cameras that have red-eye reduction control. The red-eye reduction function cannot be set on the SB-600; it can only be set on the camera. For more information, refer to your camera user's manual.
- After setting your camera to red-eye reduction, make sure that "👁" appears on the SB-600's LCD panel.

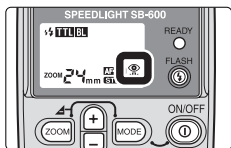

☼☼ Red-eye reduction with slow-sync flash mode

In this mode, red-eye reduction is combined with slow sync.

- Available with cameras that have a red-eye reduction setting with slow sync. This mode cannot be set on the SB-600; it can only be set on the camera. For more information, refer to your camera user's manual.
- After setting your camera to red-eye reduction with slow sync, make sure that "👁" appears on the SB-600's LCD panel.
- As slow shutter speeds are normally used for slow sync, a tripod is recommended to prevent camera shake.

●● Rear-curtain sync

Unnatural-looking pictures can occur when using flash to shoot fast-moving subjects at slow shutter speeds, because the subject frozen by the flash appears behind or within the blurred movement (see photo below, right). By using rear-curtain sync, however, the blur created by a moving subject, such as the taillights of a car, will appear behind the subject and not in front.

- In front-curtain sync, the flash fires immediately after the front curtain opens completely; in rear-curtain sync, the flash fires just before the rear curtain starts to close.
- Available with cameras that have rear-curtain sync. This mode cannot be set on the SB-600; it can only be set on the camera. For more information, refer to your camera user's manual.
- As slow shutter speeds are normally used for rear-curtain sync, a tripod is recommended to prevent camera shake.
- In multiple flash, the master flash unit can be set to either front-curtain or rear-curtain sync flash. However, the remote units cannot be set to rear-curtain sync flash (p. 58).



Rear-curtain sync



Front-curtain sync

Shooting data

- Focal length: 70mm
- Shutter speed: 2 sec.
- Aperture: f/4.5
- Flash mode: Manual
- Flash output level: M1/1



Auto FP High-Speed Sync mode (for compatible cameras)

High-Speed flash synchronization at your camera's highest shutter speed is now possible. In this mode, the Auto FP High-Speed Sync mode is automatically set when the shutter speed exceeds the camera's sync shutter speed. This is useful when you want to use a wider aperture to achieve shallow depth of field to blur the background.

- Available with compatible cameras. You cannot set the Auto FP High-Speed sync mode on the SB-600 directly, but must set it on the camera.
- When set on the camera, the **FP** indicator appears on the LCD panel.
- High-speed flash synchronization is possible exceeding your camera's sync shutter speed up to your camera's highest shutter speed.
- Auto FP High-Speed sync also operates in the Advanced Wireless Lighting mode.
- Available flash modes are i-TTL and Manual flash.

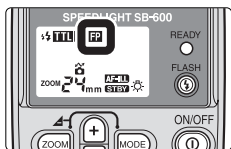

Usable flash shooting distance ranges in Auto FP High-Speed Sync (in TTL mode) (m/ft.)

		ISO sensitivity							Zoom-head position (mm)							
		1600	800	400	200	100	50	25	14*1	24	28	35	50	70	85	
Aperture	2.8	2	1.4													Flash shooting distance range (m/ft.)
	4	2.8	2	1.4												
	5.6	4	2.8	2	1.4			0.6-2.7/ 2.0-9.5	0.6-5.0/ 2.0-16.7	0.6-5.5/ 2.0-18.1	0.6-6.3/ 2.0-20.8	0.6-7.2/ 2.0-23.6	0.6-8.0/ 2.0-26.4	0.6-8.4/ 2.0-27.8		
	8	5.6	4	2.8	2	1.4		0.6-1.9/ 2.0-6.4	0.6-3.6/ 2.0-11.8	0.6-3.9/ 2.0-12.8	0.6-4.5/ 2.0-14.7	0.6-5.1/ 2.0-16.7	0.6-5.7/ 2.0-18.7	0.6-6.0/ 2.0-19.6		
	11	8	5.6	4	2.8	2	1.4	0.6-1.3/ 2.0-4.5	0.6-2.5/ 2.0-8.3	0.6-2.7/ 2.0-9.0	0.6-3.1/ 2.0-10.4	0.6-3.6/ 2.0-11.8	0.6-4.0/ 2.0-13.2	0.6-4.2/ 2.0-13.9		
	16	11	8	5.6	4	2.8	2	0.6-0.9/ 2.0-3.2	0.6-1.8/ 2.0-5.9	0.6-1.9/ 2.0-6.4	0.6-2.2/ 2.0-7.3	0.6-2.5/ 2.0-8.3	0.6-2.8/ 2.0-9.3	0.6-3.0/ 2.0-9.8		
	22	16	11	8	5.6	4	2.8	0.6-0.6/ 2.0-2.2	0.6-1.2/ 2.0-4.1	0.6-1.3/ 2.0-4.5	0.6-1.5/ 2.0-5.2	0.6-1.8/ 2.0-5.9	0.6-2.0/ 2.0-6.6	0.6-2.1/ 2.0-6.9		
	32	22	16	11	8	5.6	4		0.6-0.9/ 2.0-2.9	0.6-0.9/ 2.0-3.2	0.6-1.1/ 2.0-3.6	0.6-1.2/ 2.0-4.1	0.6-1.4/ 2.0-4.6	0.6-1.5/ 2.0-4.9		
			32	22	16	11	8	5.6	0.6-0.6/ 2.0-2.0	0.6-0.6/ 2.0-2.2	0.6-0.8/ 2.0-2.6	0.6-0.9/ 2.0-2.9	0.6-1.0/ 2.0-3.3	0.6-1.0/ 2.0-3.4		
				32	22	16	11	8					0.6-0.6/ 2.0-2.0	0.6-0.7/ 2.0-2.3	0.6-0.7/ 2.0-2.4	
					32	22	16	11								

*1 With the wide-flash adapter in place

Guide number in Auto FP High-Speed Sync (ISO 100, m/ft)

Flash output level	Zoom-head position (mm)						
	14*	24	28	35	50	70	85
M1/1	3.9/12.7	7.2/23.6	7.8/25.5	9.0/29.5	10.2/33.4	11.4/37.4	12.0/39.3
M1/2	2.7/9.0	5.0/16.7	5.5/18.0	6.3/20.8	7.2/23.6	8.0/26.4	8.4/27.8
M1/4	1.9/6.3	3.6/11.8	3.9/12.7	4.5/14.7	5.1/16.7	5.7/18.7	6.0/19.6
M1/8	1.3/4.5	2.5/8.3	2.7/9.0	3.1/10.4	3.6/11.8	4.0/13.2	4.2/13.9
M1/16	0.9/3.1	1.8/5.9	1.9/6.3	2.2/7.3	2.5/8.3	2.8/9.3	3.0/9.8
M1/32	0.6/2.2	1.2/4.1	1.3/4.5	1.5/5.2	1.8/5.9	2.0/6.6	2.1/6.9
M1/64	0.4/1.5	0.9/2.9	0.9/3.1	1.1/3.6	1.2/4.1	1.4/4.6	1.5/4.9
M1/128	0.3/1.1	0.6/2.0	0.6/2.2	0.7/2.6	0.9/2.9	1.0/3.3	1.0/3.4

* With the wide-flash adapter in place

- The guide number in Auto FP High-Speed Sync above is applicable when the shutter speed is set at 1/500 sec.
- The guide number in Auto FP High-Speed Sync above varies according to shutter speed. For example, when the shutter speed changes from 1/500 sec. to 1/1000 sec., the guide number decreases by 1 EV. This means that the higher the shutter speed, the lower the guide number.

ISO sensitivity factors

For sensitivities other than ISO 100, multiply the guide number by the factors shown in the table below.

ISO	25	50	100	200	400	800	1600
Factors	0.5	0.71	1	1.4	2	2.8	4

Flash Value Lock (FV Lock) (for compatible cameras)

Flash Value, or “FV,” is the amount of flash exposure for the subject. Using FV Lock with compatible cameras, you can lock in the appropriate flash exposure for the main subject. This flash exposure remains locked in, even if you change the aperture or composition, or zoom the lens in and out.

- Available with compatible cameras. You cannot set the FV Lock function on the SB-600 directly. Set it on the camera.
- Available flash mode is i-TTL.

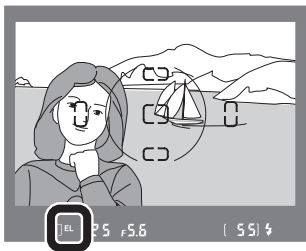

Autofocus flash operation in dim light

When the light is too dim for normal autofocus operation, the SB-600's Wide-Area AF-Assist Illuminator enables you to perform autofocus flash photography.

- In dim light, the Wide-Area AF-Assist Illuminator turns on automatically when the camera's shutter release button is lightly pressed, if an AF lens is mounted and the camera's focus mode is set to S (Single Servo AF with focus priority), AF, or A.
- The effective shooting distance with the Wide-Area AF-Assist Illuminator is approx. 1m to 10m (3.3 to 33 ft.) with a 50mm f/1.8 lens or less, depending on the lens in use.
- Usable lens focal length: 24mm to 105mm (35 to 105mm for F-501/N2020 cameras).
- Use the center focus area in your camera's viewfinder when using the wide-area AF-Assist Illuminator (for cameras not compatible with CLS).



For cameras compatible with CLS

- The SB-600's Wide-Area AF-Assist Illuminator supports the dynamic-area AF system of cameras compatible with CLS.
- With a D2H camera, for example:
Usable lens focal length: 24mm to 105mm.
A total of 11 focus areas are usable at a lens focal length of 35mm or longer as shown in the figure below.
A total of 9 focus areas excluding the extreme right- and left-hand ones are usable at a lens focal length of less than 35mm.

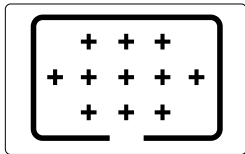

- With AF cameras such as the D2H, the effective shooting range of the wide-area AF-assist Illuminator is approx. 1m to 10m (3.3 to 33 ft.) or less in the mid portion of the frame, and 1m to 7m (3.3 to 23 ft.) or less at the periphery (with a 50mm f/1.8 lens). These ranges may vary depending on the lens in use.
- For details, see your camera's user's manual.

Autofocus flash operation in dim light

✔ Notes on using the Wide-Area AF-Assist Illuminator

- If the focus indicator does not appear in the camera's viewfinder even through the Wide-Area AF-Assist Illuminator turns on, focus manually.
- The Wide-Area AF-Assist Illuminator will not light up, if the camera's autofocus is locked or the SB-600's ready-light does not come on.
- Refer to your camera's user's manual for more information.

✔ Activating and canceling the Wide-Area AF-Assist Illuminator

You can set the SB-600's Wide-Area AF-Assist Illuminator to activate or cancel in the Custom Settings mode (p. 53).

- By default, the Wide-Area AF-Assist Illuminator is set to activate.

✔ For cameras having a built-in Speedlight

- Even when the camera's AF-Assist Illuminator is set to activate, the SB-600's Wide-Area AF-Assist Illuminator is given priority and the camera's AF-Assist Illuminator does not light up. However, the camera's AF-Assist Illuminator lights up only when the SB-600's Wide-Area AF-Assist Illuminator is canceled.
- With F80-Series/N80-Series, F75-Series/N75-Series and F65-Series/N65-Series cameras, the camera's AF-Assist Illuminator lights up when the SB-600's Wide-Area AF-Assist Illuminator is canceled. To cancel the camera's AF-Assist Illuminator, cancel it on the camera. For details, refer to your camera's user's manual.
- With F60-Series/N60 cameras, the camera's AF-Assist Illuminator lights up while shooting at full output manual. For details, refer to your camera's user's manual.

✔ Using the SB-600 off-camera

When using the SB-600 off-camera with the TTL Remote Cord SC-29, autofocus flash photography in dim light is possible, because the SC-29 features an AF-assist illuminator function (p. 83).

Custom Settings

The SB-600 can easily set, activate or cancel various operations using the Custom Settings shown on the opposite page. The displays on the LCD panel vary depending on the settings and the camera/lens combinations used.

No item appears when the settings are not available.

Setting Custom Settings

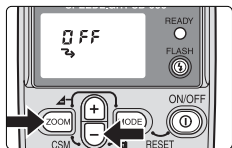

- 1** Press the **ZOOM** and **MODE** buttons simultaneously for approx. 2 seconds to display the Custom Settings mode.

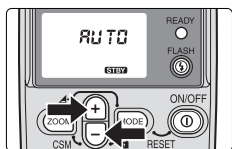

- 2** Press the **+** or **-** button to choose the desired custom settings.

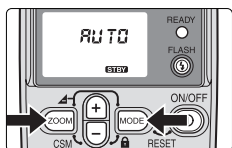

- 3** Press the **ZOOM** or **MODE** button to display the preferred setting.

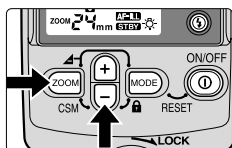

- 4** Press the **ZOOM** and **MODE** buttons simultaneously for approx. 2 seconds or press the **ON/OFF** button to return to the normal setting mode.

Details on Custom Settings (Bold: default setting)

Wireless remote flash mode (p. 62)

Activating or canceling the wireless remote flash function in wireless multiple flash photography.

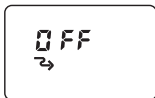

• **OFF**: Remote flash function canceled

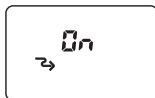

• **ON**: Remote flash function activated

Sound monitor in the wireless remote flash mode (p. 67)

When the SB-600 is used as a wireless remote flash unit in wireless multiple flash photography, you can activate or cancel the sound monitor function.



• **ON**: Sound on



• **OFF**: Sound off

Auxiliary ready-light (p. 67)

The auxiliary ready-light can be activated or canceled when the SB-600 is used as a remote flash unit in wireless multiple flash photography.

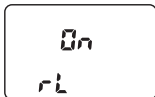

• **ON**: Ready-light is on

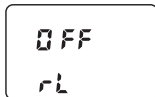

• **OFF**: Ready-light is off

Wide-Area AF-Assist Illuminator (p. 51)

Setting to activate or cancel the Wide-Area AF-Assist Illuminator.



• **AF-ILL**: Activated

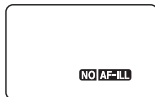

• **NO AF-ILL**: Canceled

Standby function (p. 21)

Setting the standby function to activate or cancel.



• **AUTO**: Standby function activated

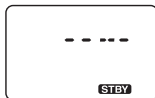

• **----**: Standby function canceled

(Bold: default setting)**Power zoom function** (p. 40)

Setting to activate or cancel the power zoom function, which adjusts the zoom-head position automatically.



- **OFF:** Activated



- **ON:** Canceled

Zoom-head position setting if the built-in wide-flash adapter is broken off accidentally (p. 88)

Setting to activate or cancel the zoom-head position setting if the built-in wide-flash adapter is broken off accidentally. When set to ON, the zoom-head position display or AUTO indicator (if a COOLPIX camera compatible with i-TTL is used) blinks.



- **OFF:** Manual setting canceled

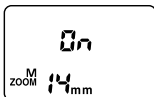

- **ON:** Manual setting activated

LCD panel illuminator (p. 15)

Setting the LCD panel illuminator to turn on or off.



- **ON:** Turn on



- **OFF:** Turn off



Advanced operations

Information on advanced flash shooting techniques using the SB-600 is described in this section.

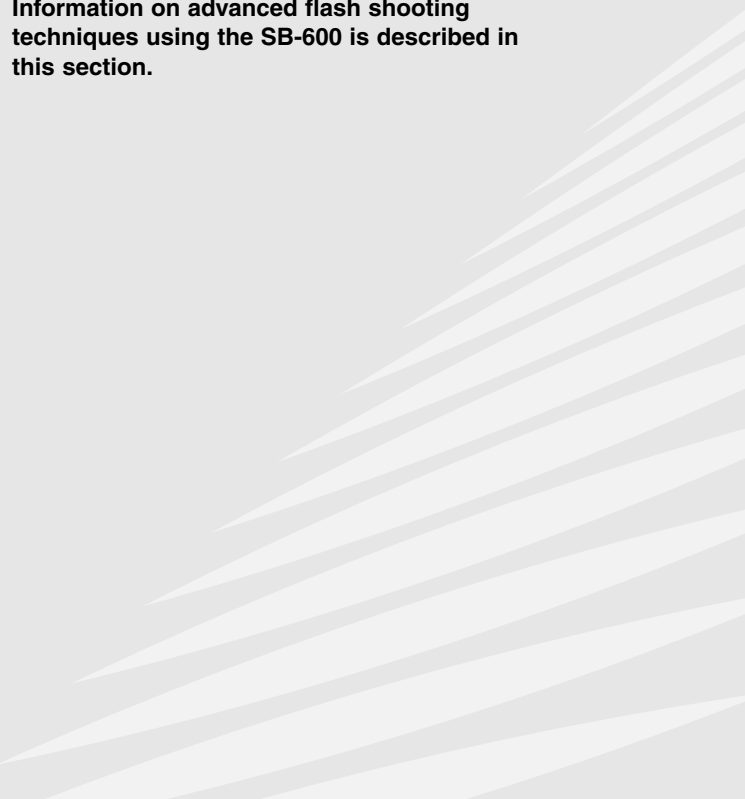

Overview of multiple flash operation

Multiple flash photography allows you to create more natural-looking pictures by using several flash units to emphasize the subject's shape or eliminate shadows. The following wireless multiple flash operations are available:

Multiple flash operation	Usable cameras	Usable Speedlights
Advanced Wireless Lighting (p. 62)	Cameras compatible with CLS	Only those featuring CLS such as SB-800 and SB-600. <ul style="list-style-type: none">• The SB-600 can be used as a remote flash unit only.
Multiple flash operation using cords (p. 68)	No limitation (TTL multiple flash operation is not possible with digital SLRs)	Speedlights compatible with the TTL mode. <ul style="list-style-type: none">• Speedlights SB-11, SB-14, SB-140, and SB-21B cannot be used with the F-401/ N4004 or F-401s/N4004s as either master or remote flash units.

- **It's not possible to use different types of multiple flash operations together.**
- Wireless multiple flash operation using Speedlights featuring CLS is called "Advanced Wireless Lighting".
- It is only possible to conduct multiple flash shooting in M (manual) mode using cords when using cameras compatible with CLS and digital SLRs not compatible with CLS.

▣ Master flash unit and remote flash unit(s)

In this user's manual, the flash unit mounted on the camera or the one directly connected to the camera via a remote cord, such as the SC-17, SC-28 or SC-29, is called the master flash unit. All other flash units are called the remote flash units.

☑ Notes on performing multiple flash (common to both wireless and wired operation)

- To avoid accidental firing, turn off the camera and all flash units before mounting the master flash unit on or connecting it to the camera.
- The SB-600's, SB-800's and SB-80DX's standby functions are canceled while the SB-50DX's standby duration is prolonged to approx. one hour when they are set to wireless remote flash mode.
- Set the angle of coverage of the remote flash units wider than the picture angle, so that the subject will receive sufficient illumination even when the angle of the flash head is off axis from the subject. (In Advanced Wireless Lighting, the zoom-head position is automatically set to 24 mm, except when the wide-flash adapter is attached.) Remember, the closer the subject, the wider the angle of coverage required.
- The brightness of the flash illumination is inversely proportional to the square of the distance between the flash unit and the subject. For example, if the distance between Speedlight A and the subject is 1 m (3.3 ft.), and Speedlight B is 2 m (6.6 ft.), the combined brightness of the two Speedlights will be:
A : B = $1^2 : 2^2 = 1 : 4$ (in meters) or $3.3^2 : 6.6^2 = \text{approx. } 11 : 44$ (in feet)
Therefore, the illumination provided by Speedlight A is four times (or two steps) brighter than that provided by Speedlight B.
- To ensure good results, it's recommended to make test shots before shooting important events.
- Be sure to read the user's manuals of your camera and Speedlight(s) before use.

Wireless multiple flash shooting

Read the following when setting up the SB-600 as a remote flash unit in the Advanced Wireless Lighting mode.

Flash set-up in the Advanced Wireless Lighting

Set up the camera, master flash unit, and remote flash units as shown in the figure below.

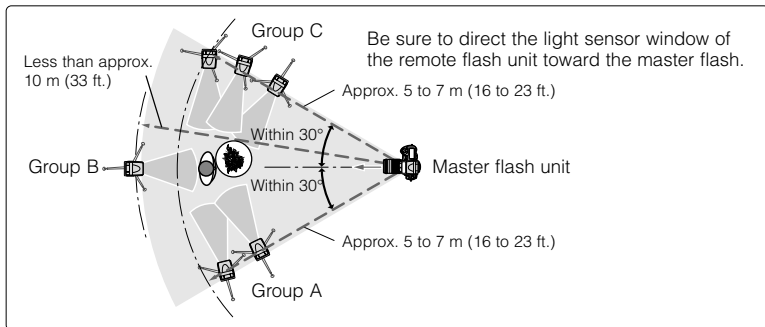

- As a basic guide, the effective shooting distance between the master and remote flash units is approx. 10 m (33 ft.) or less in the front position, and approx. 5 to 7 m (16 to 23 ft.) at both sides. These ranges vary slightly depending on the ambient light.
- Be sure to place all remote flash units that are set in the same group close together.

Setting up the master and remote flash units.

- In most cases, position the remote flash unit(s) closer to the subject than the camera, so that light from the master flash unit can reach the light sensor of the remote flash unit(s). This is particularly necessary when holding a remote flash unit in your hand.
- Data communication cannot be performed properly if there is an obstacle between the master unit and remote flash units.
- Take care not to let light from the remote flash unit enter the camera lens directly or indirectly in TTL auto flash mode. Also, prevent light from entering the master flash unit's light sensor in Non-TTL auto flash mode. Otherwise, the correct exposure cannot be obtained.
- There is no limit to the number of remote flash units that can be used together. However, if too much light from other remote flash units enters the light sensor of the master flash unit, correct operation may be impossible. For practicality, the number of remote flash units should be limited to three per group.
- Use the provided Speedlight Stand AS-19 for stable placement of the remote flash units.
- Be sure to perform test firing after setting up all flash units (p. 20).

Using the Speedlight Stand

Use the provided Speedlight Stand AS-19 for stable placement of the remote flash units.

- You can also use the stand for setting up your Nikon Speedlight when using it as a remote flash unit in multiple flash shooting using cords (p. 68).

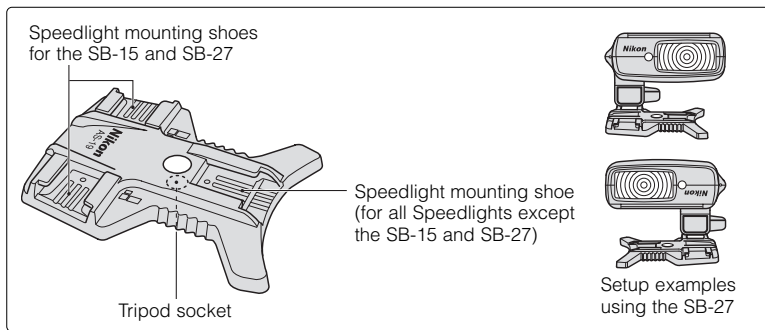

Attachment to the Speedlight Stand

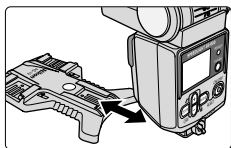

- Attach the SB-600 to the Speedlight Stand in the same way that you attach it to the camera's accessory shoe. The same is true when detaching it from the Stand.

To prevent the remote flash units from firing accidentally

- Do not leave the power of the remote flash units on. Otherwise, ambient electric noise due to a discharge of static electricity, etc. may trigger them accidentally.

Flash shooting in Advanced Wireless Lighting

Advanced Wireless Lighting is possible when Nikon Speedlights featuring CLS are used with Nikon cameras compatible with CLS.

The SB-600 can be used as a remote flash unit only.

In this mode, you can divide the remote flash units into a maximum of three groups (A, B, C) and set the flash mode and flash output level compensation values separately for each group as well as the master flash unit, providing automatic control of the light output.

Setting the SB-600 as a remote flash unit

For Advanced Wireless Lighting, the SB-600 can be set to the wireless remote flash mode using Custom Settings (p. 53).

- The indicator  appears on the LCD panel.

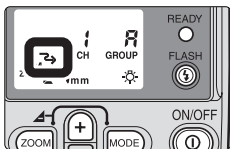

Notes on setting the flash mode when the SB-600 is used as a remote flash unit

In Advanced Wireless Lighting, set the flash mode of the remote flash units on the master flash unit; therefore, when the SB-600 is used as a remote flash unit, do not set the SB-600's flash mode to Auto Aperture (AA) or Non-TTL auto (A) flash because these modes are not available with the SB-600. If set, the SB-600 will not fire.

Settings on the remote flash units

In the Advanced Wireless Lighting mode, set the following items on the remote flash units.

Communication channel	Select one of the four available channels. Be sure to set the same channel number for both the master flash unit and remote flash units
Group name	A maximum of 3 groups (A, B, C)

- Set the remote flash units' flash modes and flash output level compensation values on the master flash unit.
- If wireless repeating flash has been set on the master flash unit, remote flash units such as the SB-600 will also perform repeating flash operation.
- If a photographer uses the same type of wireless remote flash setup near you, your remote flash units may accidentally fire in sync with that photographer's master flash unit. To avoid this, use a different channel number.
- Refer to your Speedlight user's manual for information on master flash unit settings.

Setting a group and channel number on the remote flash units

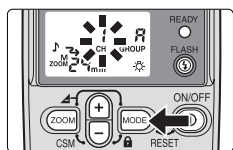

- 1 Press the **MODE** button on the remote flash unit to display the blinking channel number, then press the **+** or **-** button to set the channel number.
 - Be sure to choose the same channel number as set on the master flash unit.

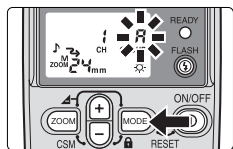

- 2 Press the **MODE** button on the remote flash unit to display the blinking group, press the **+** or **-** button to set the group, then press the **MODE** button.
 - For remote flash units where the flash mode and flash output level compensation values are to be set identically, place these flash units into the same group.

Notes on using camera's built-in flash in Commander mode

Camera	Available flash mode of built-in flash	Usable channel number	Usable group
D700, D300-Series, D200, D90, D80	TTL, M, -- (Flash canceled)	1 to 4	A, B
D70-Series	(Flash canceled)	3	A

Flash shooting in Advanced Wireless Lighting

Examples of flash shooting in Advanced Wireless Lighting



Wireless multiple flash (three flash units)



On-camera single flash

The master flash unit M illuminates the subject while the light from the remote flash unit A is bounced off the ceiling to illuminate the background and create a more natural-looking picture. Remote flash unit B is used with a colored gel filter to create the warmth feeling of a fireplace.

Shooting data

- Camera: D2H
- Focal length: 25 mm
- Master flash unit M: SB-800 (TTL, +1/3 flash output level compensation)
- Remote flash unit A: SB-600 (TTL, +1/3 flash output level compensation)
- Remote flash unit B: SB-600 (M, 1/16 flash output level)

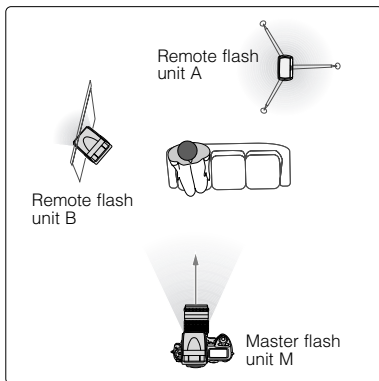

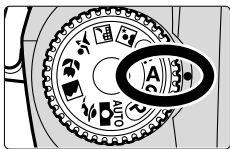

- 1 Set the camera's exposure mode to Aperture-Priority Auto (A).

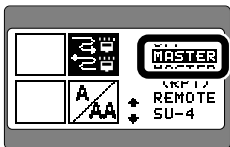

- 2 Set up the on-camera Speedlight with CLS.
 - Refer to your Speedlight user's manual.

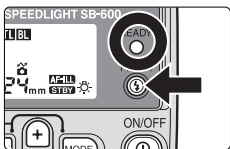

- 3 Set up remote flash units A and B. Turn the power on, then confirm that the ready-lights come on.
 - Use a tripod or the Speedlight Stand AS-19 for placement of the remote flash units (p. 61).

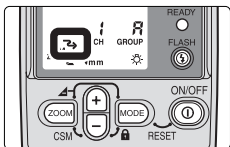

- 4 Set the remote flash units A and B to the wireless remote flash mode.

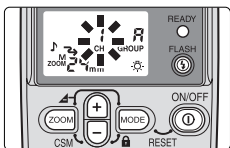

- 5 Set the channel number of the remote flash units A and B to 1.
 - Be sure to choose the same channel number as set on the master flash unit.

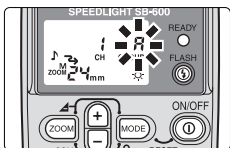

- 6 Set the group of the remote flash units A and B.
 - Set the remote flash unit A to group A and the remote flash unit B to group B.

Flash shooting in Advanced Wireless Lighting

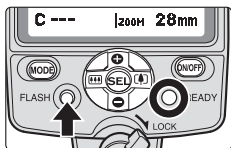

7 Confirm that all the ready-lights of the master and remote flash units are on, then press the **FLASH** button on the master flash unit to test fire the units.

- The master flash unit fires first, then the remote flash units in group A fire, followed by those in group B.
- If a certain remote flash unit does not fire, change the setup by moving the remote unit closer to the subject or redirect its light sensor window toward the master flash unit, then test fire the new setup.
- You can check the illumination before actually taking pictures using the Modeling illuminator (p. 45).

8 Finally confirm the aperture and flash shooting distance just as in TTL flash shooting, then shoot.

- Refer to page 17 for TTL flash shooting.
- Flash operation can be confirmed by the ready-light or the beeping sound (p. 67).

Modeling illuminator in the Advanced Wireless Lighting mode

When the Modeling illuminator button of the master flash unit (featuring CLS) is pressed, the Modeling illuminator of all remote flash units set on the Master flash unit will fire. Further, when the compatible camera's Modeling illuminator button is pressed, the Modeling illuminator of the master flash unit and all other remote flash units fire.

- The Modeling illuminator function operates for 1 second.
- Both the master and remote flash units fire at the flash output level compensation value as set.
- Refer to your compatible camera user's manual for details on the camera's Modeling illuminator.

Performing wireless multiple flash shooting with the COOLPIX P6000

- With the COOLPIX P6000, wireless multiple flash shooting is possible when the SB-800, SB-900 or Wireless Speedlight Commander SU-800 is used as a master flash unit and the SB-600, SB-800 or SB-900 as remote flash unit(s). Set the flash mode of the master flash unit to "Commander" and remote flash unit(s) to "Remote". The SB-800 or SB-900 used as a master flash unit and set to "Commander" cannot be fired. The COOLPIX P6000's built-in flash cannot be used as a master flash unit.
- Set the group of remote flash unit(s) to "A" (other groups cannot be used). Set the flash mode of flash unit(s) in group A to TTL, and the master and remote flash unit(s) in groups B and C to "----" (flash cancelled).

Confirming wireless multiple flash operation using the ready-light or the beeping sound

You can confirm wireless multiple flash operation by checking the auxiliary ready-light on the SB-600 or the beeping sound during and after shooting.

●● Using the SB-600's ready-light and beeping sound in the wireless remote flash mode

When the SB-600 is used as a wireless remote flash unit, you can monitor its operation by checking the auxiliary ready-light and listening to the beeping sound. This function can be activated or canceled using the Custom Settings (p. 53).

Confirming flash operation using the ready-light or beeping sound

Master flash unit	Remote flash unit		Speedlight condition
	Ready-light	Auxiliary ready-light	
Lights up	Blinks slowly	One beep	Ready to fire
Lights up when recycling is completed after firing.	Blinks slowly when recycling is completed after firing.	Two beeps	Fired properly
Blinks for approx. 3 sec.	Blinks quickly for approx. 3 sec.	Beeps for approx. 3 sec.	Both the master and remote flash units have fired at full output and light may have been insufficient for correct exposure. Use a wider aperture and reshoot.
Lights up when recycling is completed after firing.	Blinks quickly for approx. 3 sec.	Beeps for approx. 3 sec.	The remote flash unit has fired at full output and light may have been insufficient for correct exposure. The light sensor could not detect when to stop firing in sync with the master flash unit, because a strong reflection from the remote flash unit itself or light from another remote flash unit may have entered the light sensor window. Change the direction or position of the remote flash unit and reshoot.
—	Blinks quickly and goes out repeatedly for approx. 6 sec.	High and low tone beeps alternate for approx. 6 sec.	The flash mode of the remote flash unit is set to Non-TTL auto flash on the Master flash unit. Reset the flash mode to TTL , Manual M or Repeating flash RPT mode. The same is applied when the signal from the Master flash unit cannot be received correctly.

Multiple flash shooting using cords

The SB-600 can be used with Speedlights compatible with the TTL auto flash mode to perform multiple flash shooting using cords.

- When using a Speedlight that has a standby function as a remote flash unit, make sure that the standby function is set to off, or select a standby duration that is long enough by using the Custom Settings.
- Use of the SB-50DX and SB-23 as remote flash units is not recommended, because the standby function cannot be canceled.
- Speedlights SB-11, SB-14, SB-140, and SB-21B cannot be used with the F-401/N4004 or F-401s/N4004s as either master or remote flash units.
- There is no limitation in usable cameras.
- With cameras compatible with CLS and digital SLRs not compatible with CLS, Manual flash operation only is possible.

Be sure to cancel the master flash unit's Monitor Preflashes setting

When shooting with multiple flash using cords in the TTL mode, cancel the master flash unit's Monitor Preflashes setting by following one of the methods described below. Monitor Preflashes can cause incorrect exposures.

SB-800	<ul style="list-style-type: none">• Set the SU-4 type wireless multiple flash mode
SB-80DX, SB-50DX	<ul style="list-style-type: none">• Set the wireless flash mode.
SB-800, SB-600, SB-80DX, SB-50DX, SB-28, SB-28DX, SB-27, SB-26, SB-25	<ul style="list-style-type: none">• Set the flash mode to Standard TTL flash.• Tilt the flash head up.• Use a non-CPU lens.
Built-in Speedlight (F80-Series/N80-Series, F75-Series/ N75-Series, F70-Series/N70)	<ul style="list-style-type: none">• Set the camera's exposure mode to Manual (M)

- Cancel the master flash unit's Monitor Preflashes setting when performing SU-4 type wireless multiple flash operation using the SB-600 as a master flash unit. For details, refer to user's manuals provided with the Wireless Slave Flash Controller SU-4 and Speedlights (such as SB-800) featuring SU-4 type multiple flash operation.

●● The maximum number of flash units to be connected using cords

- Up to five units including the master flash unit can be used for multiple flash photography at a total cable length of 10m (33 ft.).
- Make sure the combined total of the coefficients in the table below for all flash units used together does not exceed 20 at 20°C (68°F) or 13 at 40°C (104°F).
- If it exceeds these figures, you may not be able to take a second shot after the first one. In this case, turn off the power of all flash units and reduce the total number of flash units connected.

Speedlight	Coefficient
SB-800, SB-600, SB-80DX, SB-50DX, SB-30, SB-29, SB-29s, SB-28, SB-28DX, SB-27, SB-26, SB-25, SB-24, SB-22s, SB-14, SB-11, SB-140	1
SB-23, SB-21, SB-17, SB-16, SB-15	4
SB-22	6
SB-20	9

●● Notes on multiple flash shooting using cords

- Be sure to see the user's manuals of your cameras, Speedlights, and accessories.
- Use the optional Multi-Flash Adapter AS-10, if the remote flash units are not equipped with multiple flash terminals.
- Use the optional Multi-Flash Adapter AS-10 to attach the remote flash unit(s) to a tripod.
- Use the optional TTL Multi-Flash Sync Cords SC-27, SC-26, SC-19 or SC-18 to connect the SB-600 to more than one remote flash unit.
- Multiple flash shooting using cords can be performed in two modes: (1) TTL multiple flash; and (2) Manual multiple flash. Performing multiple flash shooting in the Manual mode, however, is not recommended, since it is difficult to obtain the correct exposure. Use the TTL auto flash mode with cameras compatible with TTL auto flash.
- To ensure proper exposure, make test shots before shooting important events.

System chart for TTL multiple flash shooting using cords

- With the F6, it is not possible to use Auto FP High-Speed Sync and FV Lock operation at the same time.
- Speedlights SB-11, SB-14, SB-140, and SB-21B cannot be used with the F-401/N4004 or F-401s/N4004s as either master or remote flash units.

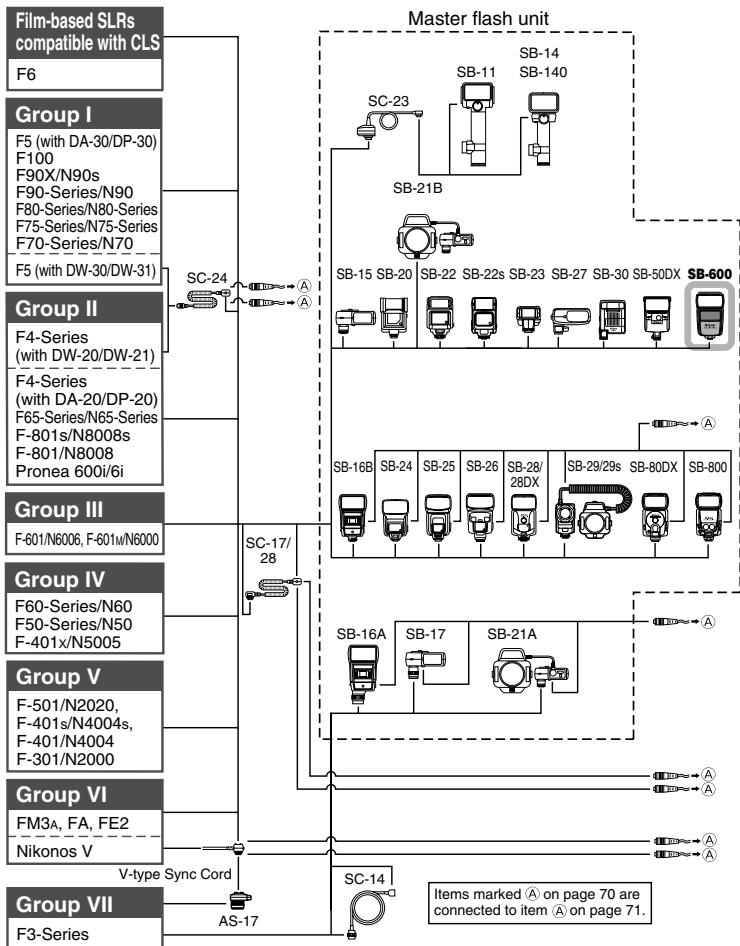

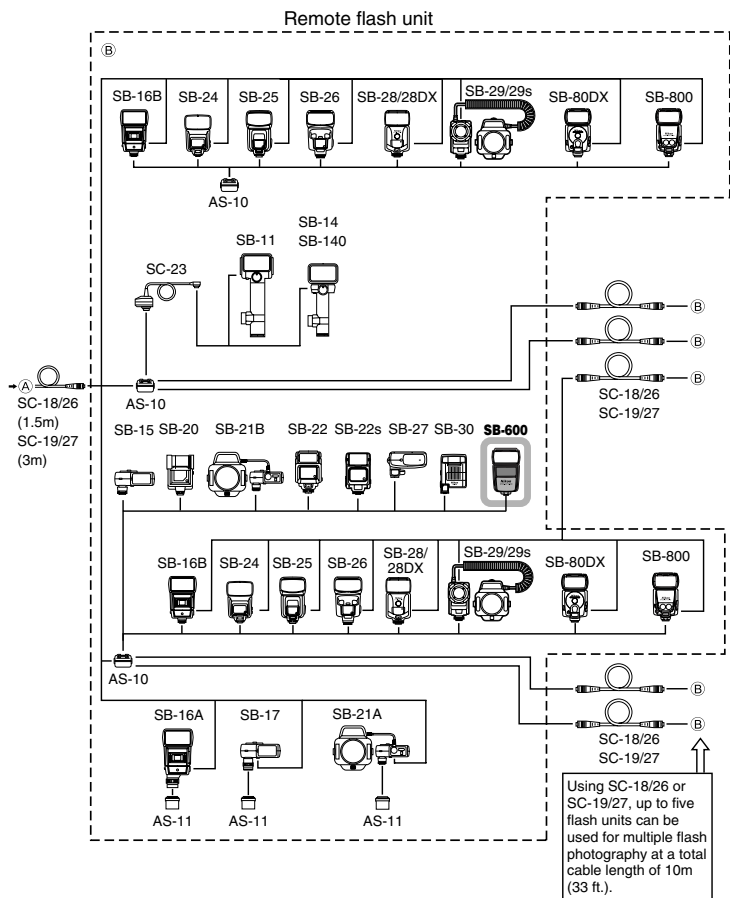

Bounce flash operation

With the SB-600 mounted on your camera's hot shoe, you can tilt or rotate the flash head to bounce the light off the ceiling or walls. This is a good technique to use when shooting indoors, because you get more natural-looking pictures of people with softer shadows.



Bounce flash



Normal flash

Shooting data:

- Camera: D2H
- Focal length: 60 mm
- Speedlight: SB-600 set to **TTL**
- Aperture: f/8
- Shooting distance: Approx. 4m (13.1 ft.)

Shooting data:

- Camera: D2H
- Focal length: 60 mm
- Speedlight: SB-600 set to **TTL**
- Aperture: f/9
- Shooting distance: Approx. 4 m (13.1 ft.)

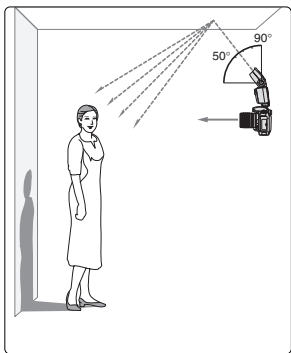

Tilting the flash head

For effective bounce flash off the ceiling, tilt the flash head up at least 50°. Also, make sure that the light from the flash head does not directly illuminate the subject.

- Optimum results are obtained when the flash head is positioned 1-2m (3.3-6.6 ft.) from the reflecting surface.

Choosing the reflecting surface

In color photography, select white or highly reflective surfaces to bounce the light off of. Otherwise, your pictures will come out with an unnatural color cast similar to that of the reflecting surface.

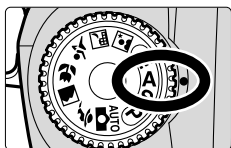

- 1** Set the camera's exposure mode to Aperture-Priority Auto (A) or Manual (M).

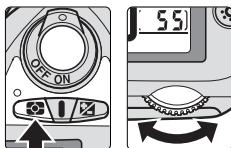

- 2** Set the camera's metering system to Matrix Metering  or Center-Weighted Metering .

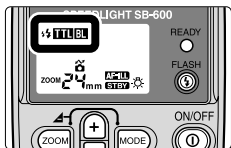

- 3** Set the flash mode to TTL auto flash.

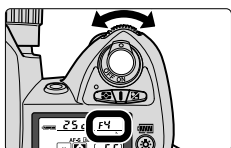

- 4** Set the camera's aperture.
- Between 2 and 3 stops of light can be lost when using bounce flash, compared with normal flash photography, so use a wider aperture.

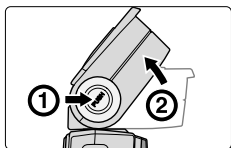

- 5** Adjust the flash head.

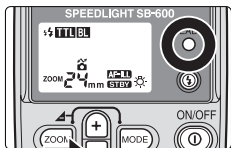

- 6** Make sure that the ready-light is on, then shoot.
- When the flash has fired at its maximum output and underexposure may have occurred, the ready-light on the SB-600 blinks for approx. 3 sec. To compensate, use a wider aperture or move closer to the subject and reshoot.

Bounce flash operation

Setting the flash head

As shown in the illustrations, tilt or rotate the SB-600's flash head by holding down the flash head tilting/rotating lock release button and adjusting the flash head to match the shooting environment or your creative preferences.

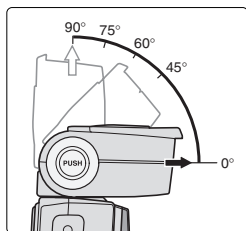

Flash head tilting and rotating angles

The SB-600's flash head tilts from 0° to 90°, and rotates horizontally 180° to the left and 90° to the right.

- Set the flash head at a click stop at the angles shown.

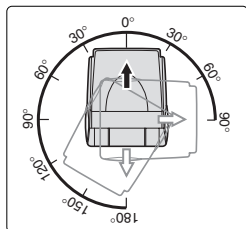

Close-up flash operation

When the built-in wide-flash adapter is used, close-up flash shooting can be performed. The built-in wide-flash adapter diffuses the light from the flash to soften shadows. When the SB-600 is used off-camera, you can take more natural-looking close-up pictures.

- Be sure to use the wide-flash adapter when taking close-up flash photographs.
- Be careful when using a long lens that the light from the flash is not obstructed by the lens barrel.
- Vignetting may occur in close-up flash photography due to the lighting situation, lens in use, focal length setting, etc. Therefore, make test shots before shooting an important assignment.



Flash shooting with two flash units (light bounced from the side and top)



Flash shooting with one camera-mounted flash unit

Shooting data:

- Camera: D2H
- Focal length: 50 mm
- Master flash unit: SB-800 set to **TTL**
- Remote flash unit: SB-600 set to **TTL**
- Aperture: f/20
- Shooting distance: Approx. 1.5 m (4.9 ft.)

Shooting data:

- Camera: D2H
- Focal length: 50 mm
- Master flash unit: SB-800 set to **TTL**
- Aperture: f/10
- Shooting distance: Approx. 1.5 m (4.9 ft.)

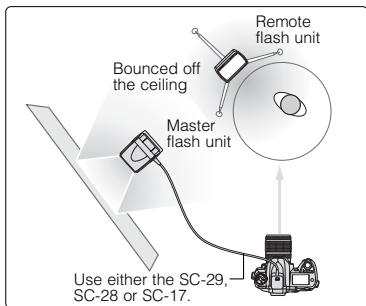

Example of close-up shooting with two flash units

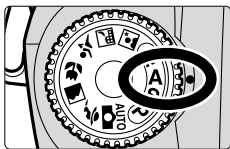

Illumination bounced from the side and top provided by two flash units eliminates background shadows to soften the subject's appearance.

Close-up flash operation

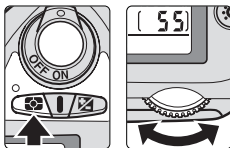

- 1** Set the camera's exposure mode to Aperture-Priority Auto (A) or Manual (M).



- 2** Set the camera's metering system to Matrix Metering  or Center-Weighted Metering .

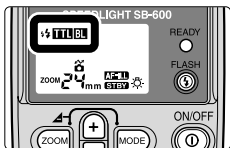

- 3** Set the SB-600's flash mode to TTL auto flash.

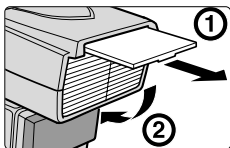

- 4** Gently pull out the built-in wide-flash adapter and position it over the flash head.

- The zoom-head position is automatically set at 14 mm when using the built-in wide-flash adapter.
- To slide the wide-flash adapter back into place, lift and push it into the flash head as far as it will go.

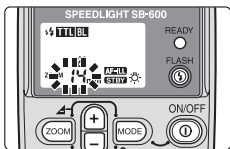

- 5** Confirm that the ready-light is on, then shoot.

- When the flash has fired at its maximum output and underexposure may have occurred, the ready-light on the SB-600 blinks for approx. 3 sec. To compensate, use a wider aperture or move closer to the subject and reshoot.

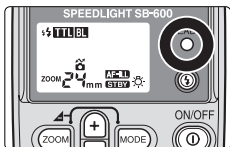

Setting the aperture

Calculate the aperture by using this equation and table. To ensure the correct exposure, use an aperture smaller than the one obtained from the equation.

ISO sensitivity	25	50	100	200	400	800	1000
Coefficient (m/ft)	1.4/4.6	2/6.6	2/6.6	4/13	4/13	5.6/18	5.6/18

$$f/\text{stop} \geq \text{Coefficient} \div \text{Flash-to-subject distance}$$

For example, at an ISO sensitivity of 100 with a subject 0.5 m (1.6 ft.) away and the wide-flash adapter in place, the suggested aperture is:

$$f/\text{stop} \geq 2 \div 0.5 = 4 \text{ (in meters)}$$

$$f/\text{stop} \geq 6.6 \div 1.6 = \text{approx. } 4 \text{ (in feet)}$$

Therefore, you should use at least f/4 or an even smaller aperture, such as f/5.6 or f/8.

When shooting subjects closer than 0.6 m (2 ft.)

With the SB-600 attached to the camera, sufficient illumination of the subject cannot be obtained. In this case, use the SB-600 off-camera by attaching the optional TTL Remote Cord as shown below.

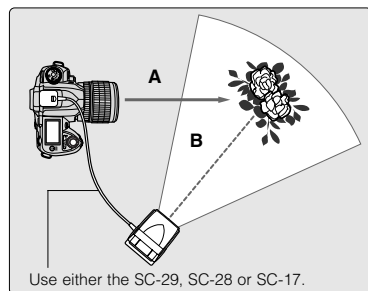

- In **TTL B** flash operation where Monitor Preflashes are fired, when the SB-600 is used with D/G-type CPU lenses, you may not be able to get the correct exposure, because distance information from the lens is used. In this case, position the camera (A) and the SB-600 (B) at equal distances from the subject.
- For F5 cameras with the High-Magnification Finder DW-30 or DW-31, or F4 cameras with the High-Magnification Finder DW-20 or DW-21, use the optional TTL Remote Cord SC-24 instead of the SC-17.

Flash shooting in the 1/300 TTL High-Speed Flash sync mode (F5 only)



Use the guide number table and equation to calculate the farthest flash shooting distance, according to each zoom-head position.

$$D \text{ (farthest flash shooting distance)} \\ = \text{Guide number} \div f/\text{stop (aperture)}$$

Guide number (m/ft.) in the 1/300 TTL High-Speed Flash sync mode

ISO sensitivity	Zoom-head position (mm)						
	14*	24	28	35	50	70	85
25	2.9/9.5	4.7/15	5.1/17	5.6/18	6.6/22	7.3/24	8/26
50	4.0/13	6.7/22	7.2/24	8/26	9.3/31	10.3/34	11.4/37
100	5.7/19	9.4/31	10.1/33	11.3/37	13.1/43	14.5/48	16/52
200	8/26	13.2/43	14.1/46	15.8/52	18.3/60	20/66	22.4/73
400	11.4/37	18.8/62	20.2/66	22.6/74	26.2/86	29/95	32/105
800	16/52	26.3/86	28.3/93	31.6/104	36.7/120	40.6/133	44.8/147

*With the wide-flash adapter in place

- For example, when shooting with an ISO sensitivity of 100, at a 35mm zoom-head position and an aperture of f/5.6:

$$D = 11.3 \div 5.6 \text{ (f/stop)} = 2.0 \text{ (in meters)} \\ \text{(farthest flash shooting distance)}$$

$$D = 37 \div 5.6 \text{ (f/stop)} = 6.6 \text{ (in feet)} \\ \text{(farthest flash shooting distance)}$$



Reference information







This section contains information on optional accessories, troubleshooting, Speedlight care and specifications.













































































TTL auto flash modes available with the SB-600

The available types of TTL auto flash vary, depending on the camera/lens/exposure mode/metering system in use. The following tables show the SB-600's TTL mode indicators and the corresponding ones used in the user's manuals of Speedlights featuring no CLS when the flash unit is used with various cameras not compatible with CLS.

- Refer to your camera's user's manual for specific information on camera settings and functions.

Exposure mode P : Programmed Auto S : Shutter-Priority Auto A : Aperture-Priority Auto M : Manual	Metering system  : Matrix  : Center-Weighted  : Spot
TTL/D-TTL auto flash mode  : Automatic Balanced Fill-Flash with TTL Multi Sensor  : Matrix Balanced Fill-Flash, Center-Weighted Fill-Flash/Spot Fill-Flash  : Standard TTL Flash	D-TTL Multi Sensor icon : Automatic Balanced Fill-Flash with TTL Multi Sensor for Digital SLRs D-TTL Matrix icon : Center-Weighted Fill-Flash for Digital SLRs D-TTL icon : Standard TTL Flash for Digital SLRs

Cameras compatible with the TTL/D-TTL auto flash mode

Camera group	Camera	TTL mode	TTL mode with no CLS	Exposure mode	Metering system	Lens	
Digital SLRs not compatible with CLS	D1-Series		 *1	P/S/A/M	 	CPU lens (D/G-type)	
			 *2	P/S/A/M	 	CPU lens (except for D/G-type)	
				A/M		Non-CPU lens	
				P/S/A/M	  	CPU lens	
	D100			A/M	 	Non-CPU lens	
			 *1	P/S/A/M	 	CPU lens (D/G-type)	
			 *2	P/S/A/M	 	CPU lens (except for D/G-type)	
				P/S/A/M	  	CPU lens	
					M	 	Non-CPU lens
	*1: 3D Multi-Sensor Balanced Fill-Flash for Digital SLRs is set. *2: Multi-Sensor Balanced Fill-Flash for Digital SLRs is set.						
I	F5 F100		 *2	P/S/A/M	 	CPU lens (D/G-type)	
			 *3	P/S/A/M	 	CPU lens (except for D/G-type)	
				A/M		Non-CPU lens	
				P/S/A/M	  	CPU lens	
	F90X/N90s F90-Series/ N90 F70-Series/ N70		 *2	P/S/A/M	  	CPU lens (D/G-type)*1	
			 *3	P/S/A/M	  	CPU lens (except for D/G-type)	
				A/M		Non-CPU lens	
				P/S/A/M	  	CPU lens*1	
					A/M	 	Non-CPU lens
	*1: The A and M exposure modes cannot be used with a G-type lens. *2: 3D Multi-Sensor Balanced Fill-Flash is set. *3: Multi-Sensor Balanced Fill-Flash is set.						

Camera group	Camera	TTL mode	TTL mode with no CLS	Exposure mode	Metering system	Lens	
I	F80-Series/ N80-Series		*2	P/S/A/M		CPU lens (D/G-type)	
			*3	P/S/A/M		CPU lens (Non-D/G-type AF)	
				P/S/A/M		CPU lens	
				M		Non-CPU lens*1	
	F75-Series/ N75-Series		*2	P/S/A		CPU lens (D/G-type)	
			*3	P/S/A		CPU lens (Non-D/G-type AF)	
				P/S/A/M		CPU lens	
				M		Non-CPU lens*1	
*1: The camera's exposure meter cannot be used. Set the aperture using the lens aperture ring. *2: 3D Multi-Sensor Balanced Fill-Flash is set. *3: Multi-Sensor Balanced Fill-Flash is set.							
II	F4-Series			P/S/A/M		CPU lens*1	
				A/M		Non-CPU lens*2	
			*3	P/S/A/M		CPU lens*1	
			*3	A/M		Non-CPU lens	
				P/S/A/M		CPU lens*1	
				A/M		Non-CPU lens	
	*1: The A and M exposure modes cannot be used with a G-type lens. *2: AI-S, AI, Series E lens only usable. *3: Center-Weighted Fill-Flash is set.						
	F65-Series/ N65-Series			P/S/A		CPU lens	
				P/S/A/M		CPU lens*1	
				M		Non-CPU lens*2	
	*1: Center-Weighted Metering is automatically set when the exposure mode is set to M. *2: The camera's exposure meter cannot be used. Set the aperture using the lens aperture ring.						
	F-801s/ N8008s F-801/ N8008			P/S/A/M		CPU lens*1	
		*3	P/S/A/M		CPU lens*1/*2		
		*3	A/M		Non-CPU lens*2		
			P/S/A/M		CPU lens*1/*2		
			A/M		Non-CPU lens*2		
*1: The A and M exposure modes cannot be used with a G-type lens. *2: Spot Metering is not possible with the F-801/N8008. *3: Center-Weighted Fill-Flash/Spot Fill-Flash is set.							
Pronea 600i/6i			P/S/A/M		CPU lens		
			P/S/A/M		CPU lens		
			M		Non-CPU lens*1		
*1: The camera's exposure meter cannot be used. Set the aperture using the lens aperture ring.							

TTL auto flash modes available with the SB-600

Camera group	Camera	TTL mode	TTL mode with no CLS	Exposure mode	Metering system	Lens	
III	F-601/ N6006			P/S/A/M		CPU lens (except for G-type)*1	
				P/S/A/M		CPU lens (except for G-type)*1	
				A/M		Non-CPU lens*1	
				P/S/A/M		CPU lens (except for G-type)*2	
				A/M		Non-CPU lens*2	
*1: Only appears on the SB-600's LCD panel. Matrix Balanced Fill-Flash or Center-Weighted Fill-Flash/Spot Fill-Flash is selected when appears on the camera's LCD panel.							
*2: Center-Weighted Metering is automatically set when the exposure mode is set to M.							
III	F-601M/ N6000			P/S		CPU lens*1	
				P/S		CPU lens*1	
				A/M		Non-CPU lens*1	
				P/S		CPU lens	
				A/M		Non-CPU lens	
*1: Only appears on the SB-600's LCD panel. Matrix Balanced Fill-Flash or Center-Weighted Fill-Flash/Spot Fill-Flash is selected when appears on the camera's LCD panel.							
IV	F60-Series/N60		*1	P/S/A		CPU lens	
	F50-Series/N50		*2	M		CPU/non-CPU lens	
	F-401x/N5005						
V	F-501/N2020		*3	P		CPU*4/non-CPU lens*5	
				A/M		CPU*4/non-CPU lens	
	*1: Matrix Balanced Fill-Flash is set. *2: Center-Weighted Fill-Flash/Spot Fill-Flash is set. *3: Programmed TTL Auto Flash is set. *4: G-type Nikkor lenses cannot be used. Nikkor lenses for F3AF usable. *5: AI-S, AI, Series E lenses only usable.						
	F-401s/N4004s		*2	P/S		CPU lens	
	F-401/N4004			A/M		CPU lens*1	
			M		Non-CPU lens		
*1: Center-Weighted Metering is automatically set when the exposure mode is set to M. *2: Programmed TTL Auto Flash is set.							
VI	FM3A			A/M		CPU (except G-type)/non-CPU lens	
	FA			P/A/M		CPU (except G-type)/non-CPU lens*1	
	FE2			A/M		CPU (except G-type)/non-CPU lens*1	
	Nikonos V			A/M		CPU (except G-type)/non-CPU lens*1*2	
	F3-Series			A/M		CPU (except G-type)/non-CPU lens*3	
*1: Standard TTL Flash is not possible if the shutter speed is set to M250 or B (bulb) for the FA, FE2, and M90 for the Nikonos V cameras. *2: An optional sync cord for land use is required. *3: Optional TTL Unit Coupler AS-17 is required.							

Optional accessories

●● Accessories for multiple flash

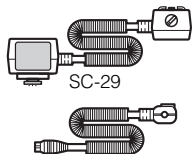

TTL Remote Cord SC-29/28/17 (approx. 1.5m or 4.9 ft)

TTL Remote Cord SC-24 (approx. 1.5m or 4.9 ft)

TTL Remote Cords SC-29/SC-28/SC-17/SC-24 provide TTL auto flash operation when the SB-600 is used off-camera. Their flash shoes come with one tripod socket and two TTL multiple flash terminals. The TTL Remote Cord SC-24 is for use with F5 cameras mounted with a High-Magnification Finder DW-30 or DW-31, or F4 cameras having a High-Magnification Finder DW-20 or DW-21. The SC-29 features an AF-assist illuminator function. (The SC-29 is not equipped with a TTL multiple flash terminal.)



TTL Multi-Flash Sync Cord SC-26/18 (approx. 1.5 m or 4.9 ft)

TTL Multi-Flash Sync Cord SC-27/19 (approx. 3 m or 9.8 ft)

Multi-Flash Sync Cords SC-18/SC-19/SC-26/SC-27 are useful for connecting the SB-600 to the multiple flash terminal of the SC-28, SC-17 or AS-10 for TTL multiple flash operation.



TTL Multi-Flash Adapter AS-10

Use the Multi-Flash Adapter AS-10 when connecting more than three flash units together for TTL multiple flash operation, or if the remote flash units are not equipped with multiple flash terminals. The AS-10 comes with one tripod socket and three TTL multiple flash terminals.



TTL Flash Unit Coupler AS-17 for F3-Series cameras

Dedicated adapter for F3-Series cameras providing TTL flash operation with Nikon Speedlights such as the SB-600 featuring an ISO-type mounting foot (not designed for the F3).



Bracket SK-7

A metal plate with attachment screws allowing the camera and Speedlight to be positioned side by side. Use the optional TTL Multi-Flash Adapter AS-10 to attach the SB-600 to Bracket SK-7.



Multi-Flash Bracket Unit SK-E900

(One AS-E900 Multi-Flash Adapter is included with the SK-E900)

Multi-Flash Adapter AS-E900

The SB-600 can be used as a multiple flash unit with Nikon COOLPIX 900-series digital cameras by attaching the COOLPIX to Multi-Flash Bracket Unit SK-E900 and connecting the SB-600 to the multi-flash terminal of the COOLPIX using the Multi-Flash Adapter AS-E900 (p. 30).



Optional accessories

Other accessories



Speedlight Stand AS-19

Same as that provided with this SB-600.

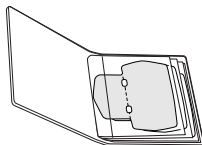

Colored Gel Filter Set SJ-1

The color of light can be balanced or specific colors can be added to a scene by using a Speedlight with the optional Colored Gel Filter Set SJ-1.

The optional Colored Gel Filter Set SJ-1 contains a total of 20 filters in 8 kinds of colored gels.

- FL-G1 (for fluorescent light)
- FL-G2 (for fluorescent light)
- TN-A1 (for incandescent/tungsten light)
- TN-A2 (for incandescent/tungsten light)
- BLUE
- YELLOW
- RED
- AMBER

The colored gel filters will fade or deteriorate with time. When this happens, replace them with the backup gels provided in the set.

Using colored gel filters with digital cameras

Purpose	Gel filter	Adjust the camera's white balance to:
Balances the color of light from the flash to match that of fluorescent light	FL-G1, FL-G2	Fluorescent
Balances the color of light from the flash to match that of incandescent or tungsten light	TN-A1, TN-A2	Incandescent
Creates interesting effects by changing the light from the flash to a different color	Blue, Yellow, Red, Amber	Flash

Balancing light from the flash

- With digital cameras, if you shoot flash pictures under fluorescent light with the camera's white balance set to "Flash," the main subject illuminated by the flash will look normal. However, the background will come out green. To compensate, use the FL-G1 (green gel filter) to convert the light coming from the flash to the same color as fluorescent light, then adjust the camera's white balance to "Fluorescent." Follow a similar procedure when shooting flash pictures under incandescent/tungsten illumination using the applicable filter. In this case, set the white balance to "Incandescent."
- Available with digital cameras featuring white balance. You cannot set the white balance on the SB-600. Choose an appropriate white balance setting on your digital camera. For more details, see your camera's user's manual.

Tips on Speedlight care



WARNING

Never use thinner, benzene, or other active agents for cleaning the Speedlight, as this may damage the Speedlight or cause it to catch on fire. Using these agents may also impair your health.

●● Cleaning

- Use a blower brush to remove dirt and dust from the SB-600 and clean it with a soft, clean cloth. After using the SB-600 near saltwater, wipe the flash unit with a soft, clean cloth moistened slightly with plain water to remove the salt, then dry it using a dry cloth.
- On rare occasions, the LCD may turn on or turn dark, due to static electricity. This is not a malfunction. The display will soon return to normal.
- Do not drop the SB-600 or hit it against a hard surface, as this may damage its precision mechanisms. Do not apply strong pressure to the LCD panel.

●● Storage

- Store the SB-600 in a cool, dry place to prevent malfunctions due to high humidity, as well as the growth of mold or mildew.
- Keep the SB-600 away from chemicals such as camphor or naphthalene. Avoid exposing the SB-600 to magnetic waves from TVs or radios.
- Do not use or leave the SB-600 in locations subject to high temperatures such as those encountered near a heater or stove, as this may cause damage.
- When not using the SB-600 for more than two weeks, be sure to remove the batteries to prevent malfunctions due to battery leakage.
- Take the SB-600 out once a month, insert the batteries, and fire the unit several times to reform the capacitor.
- When the SB-600 is stored together with a desiccant, change the desiccant occasionally since it does not absorb moisture effectively after a while.

●● Operating location

- An extreme temperature change can cause condensation inside the SB-600. When taking the SB-600 to a very hot place from a very cold place or vice versa, place it inside an airtight container such as plastic bag. Leave it inside for a while, then expose the SB-600 gradually to the outside temperature.
- Avoid exposing the SB-600 to strong magnetism or radio waves from TVs or high-voltage power transmission towers, as this may cause it to malfunction.

Notes on handling batteries

Usable batteries

Use four AA-type batteries (1.5 V or lower) of any of the following types.

- Carbon-zinc batteries are not recommended.

Alkaline-manganese (1.5 V)/Nickel (1.5 V) batteries

Non-rechargeable. Never attempt to charge these batteries in a battery charger. Otherwise, they may explode.

Lithium (1.5 V) batteries

Non-rechargeable. Never attempt to charge these batteries in a battery charger. Otherwise, they may explode.

- Depending on battery specifications, when these batteries become hot, the safety circuits are activated, cutting off power. This often occurs when the flash unit is operated in the repeating flash mode. Battery power will recover when the temperature returns to normal.

NiCd battery (rechargeable, 1.2 V) /Ni-MH (rechargeable, 1.2 V)

Rechargeable. Before recharging the batteries, be sure to read the user's manuals for your batteries and battery charger for detailed information on how to handle and recharge the batteries.



NiCd

**Recycling
rechargeable
batteries**

To protect the earth's environment, do not dispose of used rechargeable batteries yourself. Instead, take these batteries to your nearest recycling center.

Notes on batteries

- Because flash consumes a large amount of battery power, rechargeable batteries may not operate properly before reaching the end of their stated lifespan or the number of charging/discharging as specified by the battery manufacturer.
- Replace all four batteries at the same time. Do not mix battery types or brands or use old with new batteries.
- When installing batteries, turn off the power of the Speedlight and never reverse the polarity of the batteries.
- If the battery terminals become soiled, remove dirt and smudges before use, as this may cause a malfunction.
- Battery power tends to weaken as the temperature drops. It also gradually decreases when batteries are not used for a long time and recovers after a short break following intensive use. Be sure to check battery power and replace the batteries with fresh ones, if you notice any delays in the recycling time.
- Do not store batteries in locations subject to high temperatures and high humidity.

Troubleshooting

If a warning indication appears on the SB-600's LCD panel or inside the camera's viewfinder, use the following chart to determine the cause of the problem before you take your Speedlight to a Nikon service center for repair.

●● Problems with the SB-600

Problem	Cause	Ref. page
The power cannot be turned on.	The batteries are not correctly installed.	p. 18
The ready-light does not light up.	Battery power is weak.	p. 19
	The standby function is activated and operating.	p. 21
The power turns off automatically.	The batteries are extremely exhausted.	p. 19
A strange sound can be heard caused by the flash head zooming back and forth even when the SB-600 is turned off.	The batteries are extremely exhausted.	p. 19
No TTL , or BL indicator appears in TTL auto flash mode.	The camera's exposure mode or metering system is not correctly set or a non-CPU lens is mounted.	p. 80
The zoom-head position cannot be adjusted to other than 14 mm.	The built-in wide-flash adapter is in use.	p. 76, p. 88
The SB-600 does not work when control buttons (MODE button, + / ⊖ button, or ZOOM button) are pressed.	Control buttons are locked.	p. 12
The ready-light blinks for 3 sec. after firing. The underexposure indicator blinks and the amount of underexposure is displayed, depending on the camera in use.	Underexposure may have occurred.	p. 29
Three beeps sound during wireless multiple flash shooting.	The flash has fired at its maximum output and underexposure may have occurred.	p. 67
In wireless multiple flash photography, the ready-light blinks quickly and slowly and the SB-600 alternately emits high and low tone beeps for 6 seconds.	The flash mode of the remote flash unit is set to Non-TTL auto flash on the Master flash unit. Reset the flash mode to TTL , Manual M or Repeating RPT flash mode. The same is applied when the signal from the Master flash unit cannot be received correctly.	P. 67
"- -" blinks in the zoom-head position indicator.	A zoom-head position adjustment error has occurred. Turn off the SB-600 and camera, and detach the SB-600 from the camera. Then, reattach the SB-600 to the camera and turn on the power.	—

●● If the built-in wide-flash adapter is broken off accidentally

If the wide-flash adapter is subjected to a strong impact while set on the flash head, it may be broken off. In this case, visit your nearest authorized Nikon service center for repair.

- If the wide-flash adapter is broken off, it is no longer possible to set the zoom-head position to anything other than 14mm. To adjust the zoom-head position, refer to the Custom Settings "Zoom-head position setting if the built-in wide-flash adapter is broken off accidentally" (p. 53).

●● Ready-light warning inside the camera's viewfinder

Problem	Cause	Ref. page
Cameras in Groups I (except for F70-Series/N70) to VI and Digital SLR cameras		p. 22
The ready-light blinks when pressing the shutter release button slightly in the TTL auto flash mode.	The SB-600 is not correctly attached to the camera.	
Cameras in Group VI		p. 82
The ready-light blinks in the TTL auto flash mode.	The shutter speed is set to M90, M250, or B (bulb).	
FM3A, New FM2 cameras		—
The ready-light blinks.	The shutter speed set is faster than the flash sync speed.	p. 82
New FM2, F55-Series/N55-Series cameras.		
The ready-light blinks when the flash mode is set to TTL auto flash.	The SB-600's flash mode is set to TTL auto flash.	







Note

The SB-600 incorporates a microcomputer to control flash operations. In rare cases, the SB-600 may not work properly even after fresh batteries are properly installed. If this happens, replace the batteries while the SB-600's power is turned on.

Warning

- Batteries should not be exposed to excessive heat such as strong sunshine, a fire, or the like.
- Dry batteries should never be recharged in a battery charger.
- Do not expose the SB-600 to water as this may result in an electric shock or cause the unit to catch on fire.

Specifications

Electronic construction	Automatic Insulated Gate Bipolar Transistor (IGBT) and series circuitry			
Guide number (at 35 mm zoom-head position, 20°C/68°F)	30/98 (ISO 100, m/ft), 42/138 (ISO 200, m/ft)			
Flash shooting distance range (in TTL auto flash mode)	0.6m to 20m (2 to 66 ft.) (varies depending on the ISO sensitivity, zoom-head position and lens aperture in use)			
Flash exposure control				
Indicator	Available flash mode	Usable camera		
	i-TTL mode	Cameras compatible with CLS, COOLPIX cameras compatible with i-TTL		
	D-TTL mode	Digital SLRs not compatible with CLS		
	TTL (film based) mode	Cameras in Groups I to VI (film based cameras)		
 (appears with )	Balanced Fill-Flash	Cameras compatible with CLS, digital SLRs not compatible with CLS, cameras in Groups I to IV (No  appears with cameras in Groups III to IV)		
	Manual flash	No limitation		
Other available functions Test firing, Monitor Preflashes and AF-assist illuminator				
Nikon Creative Lighting System	A variety of flash operations are available with compatible cameras: i-TTL mode, Advanced Wireless Lighting, FV Lock flash, Flash color information communication, Auto FP High-Speed sync, and Wide-area AF-Assist Illuminator			
Multiple flash operation	Available multiple flash		Usable camera	
	Advanced Wireless Lighting		Cameras compatible with CLS	
	Multiple flash shooting using cords		No limitation	
Flash exposure control set on the camera	Slow-sync, Red-eye reduction, Red-eye reduction in slow-sync, Rear-curtain sync flash, Auto FP High-Speed sync, FV Lock flash			
Angle of coverage	Variable in six steps, plus one step with wide-flash adapter			
	Zoom-head position	Angle of coverage		
			Vertical	Horizontal
	14 mm*	14 mm	110°	120°
	24 mm	24 mm	60°	78°
	28 mm	28 mm	53°	70°
	35 mm	35 mm	45°	60°
	50 mm	50 mm	34°	46°
	70 mm	70 mm	26°	36°
85 mm	85 mm	23°	31°	
*With the built-in wide-flash adapter set				

Specifications

Bounce capability	Flash head tilts from 0° to 90° with click-stops at 0°, 45°, 60°, 75°, 90°; flash head rotates horizontally 180° to the left or 90° to the right with click-stops at 0°, 30°, 60°, 90°, 120°, 150°, 180°																	
ON/OFF button	<ul style="list-style-type: none"> • Press the  button for approx. 0.3 sec. to turn the SB-600 on or off. • Standby function can be set. 																	
Power source/ min. recycling time/no. of flashes (at M1/1 output)	Four AA-type penlight batteries (1.5 V or lower) of any of these types: Alkaline-manganese (1.5 V), Lithium (1.5 V), Nickel (1.5 V), NiCd (rechargeable, 1.2 V), or Ni-MH (rechargeable, 1.2 V)																	
	<table border="1"> <thead> <tr> <th>Battery type</th> <th>Min. recycling time (approx.)*</th> <th>Min. number of flashes/ recycling time (approx.)*</th> </tr> </thead> <tbody> <tr> <td>Alkaline-manganese</td> <td>3.5 sec.</td> <td>200/3.5–30 sec.</td> </tr> <tr> <td>Lithium</td> <td>4.0 sec.</td> <td>400/4.0–30 sec.</td> </tr> <tr> <td>Nickel</td> <td>2.5 sec.</td> <td>180/2.5–30 sec.</td> </tr> <tr> <td>NiCd (1000 mAh) (rechargeable)</td> <td>2.9 sec.</td> <td>90/2.9–30 sec.</td> </tr> <tr> <td>Ni-MH (2000 mA) (rechargeable)</td> <td>2.5 sec.</td> <td>220/2.5–30 sec.</td> </tr> </tbody> </table> <p>* With fresh batteries.</p> <ul style="list-style-type: none"> • M1/1 output without use of AF-assist illuminator, zoom operation, and LCD panel illuminator. 	Battery type	Min. recycling time (approx.)*	Min. number of flashes/ recycling time (approx.)*	Alkaline-manganese	3.5 sec.	200/3.5–30 sec.	Lithium	4.0 sec.	400/4.0–30 sec.	Nickel	2.5 sec.	180/2.5–30 sec.	NiCd (1000 mAh) (rechargeable)	2.9 sec.	90/2.9–30 sec.	Ni-MH (2000 mA) (rechargeable)	2.5 sec.
Battery type	Min. recycling time (approx.)*	Min. number of flashes/ recycling time (approx.)*																
Alkaline-manganese	3.5 sec.	200/3.5–30 sec.																
Lithium	4.0 sec.	400/4.0–30 sec.																
Nickel	2.5 sec.	180/2.5–30 sec.																
NiCd (1000 mAh) (rechargeable)	2.9 sec.	90/2.9–30 sec.																
Ni-MH (2000 mA) (rechargeable)	2.5 sec.	220/2.5–30 sec.																
Ready-light	<ul style="list-style-type: none"> • Lights up when the SB-600 is recycled and ready to fire. • Blinks for 3 sec. when flash fires at its maximum output, indicating light may have been insufficient (in TTL auto flash mode) 																	
Flash duration (approx.)	1/900 sec. at M1/1 (full) output 1/1600 sec. at M1/2 output 1/3400 sec. at M1/4 output 1/6600 sec. at M1/8 output 1/11100 sec. at M1/16 output 1/20000 sec. at M1/32 output 1/25000 sec. at M1/64 output																	
Mounting foot lock lever	Provides secure attachment of SB-600 to camera's accessory shoe using locking plate and mount pin to prevent accidental detachment.																	
Flash output-level compensation	–3.0 to +3.0 EV in increments of 1/3 steps in the TTL auto flash mode.																	

Custom Settings	The following Custom Settings are possible: Wireless remote flash, Auxiliary ready-light, Sound monitor in the wireless remote flash mode, Standby function, Power zoom function, Zoom-head position setting if the built-in wide-flash adapter is broken off accidentally, LCD panel illuminator, and AF-assist illuminator.
Other functions	Recalling the underexposure value in the TTL auto flash mode, Resetting the settings, Button lock
Built-in wide-flash adapter	Allows SB-600 to be used with a 14 mm lens.
Dimensions (W x H x D)	Approx. 68.0 x 123.5 x 90.0 mm (2.7 x 4.9 x 3.5 in.)
Weight (without batteries)	Approx. 300g (10.6 oz.)
Accessories supplied	Speedlight Stand AS-19 and Soft Case SS-600

These performance specifications are applicable when fresh batteries are used at normal temperatures (20°C/68°F).

Specifications and design are subject to change without notice.

- Refer to the Speedlight parts and their functions (p. 10) and Icons on the LCD panel (p. 14) for each part name and display indications.

Symbol

⊕/⊖ button.....	12
i-TTL mode	32

A

AF-ILL.....	51
Accessories.....	83
Advanced Wireless Lighting	62
Aperture-priority auto exposure (A)	25
Auto FP High-Speed sync.....	48
Automatic Balanced Fill-Flash	33

B

Batteries	18, 86
Bounce flash operation	72
Built-in wide-flash adapter	76
Button lock	12

C

CLS.....	5
COOLPIX.....	30
CPU Nikkor lenses	16
Camera groups	8
Channel	63
Close-up flash operation.....	75
Colored gel filters.....	84
Communication channel	63
Compatible with CLS	8
Continuous flash shooting.....	38
Control buttons.....	12
Custom Settings.....	53

D

D-TTL mode	32
D-type Nikkor lenses.....	16
Default settings	6
Digital SLRs not compatible with CLS	8

E

Exposure compensation	42
Exposure mode.....	24

F

FLASH button.....	12
FV Lock flash.....	50
Flash Color Information Communication.....	5
Flash head.....	74
Flash head tilting/rotating lock release button.....	22
Flash modes.....	32
Flash output level	35
Flash output level compensation value ...	44
Flash shooting distance range.....	27
Flash sync mode.....	28
Front-curtain sync	28

G

G-type Nikkor lenses.....	16
Group	8
Guide number	35

I

ISO sensitivity.....	27
ISO sensitivity factors.....	35

L

LCD panel illuminator.....	15
LCD panel	14

M

MODE button.....	26
Manual exposure (M) mode.....	25
Manual flash	36
Manual mode	34
Master flash unit.....	58

Metering system.....	24
Minimum recycling time.....	19
Modeling illuminator.....	45
Monitor Preflashes.....	32
Mounting foot lock lever.....	22
Multiple flash operation.....	58
Multiple flash shooting using cords.....	68

N

Nikon Creative Lighting System.....	5
NO AF-ILL.....	51
Non-CPU lenses.....	16
Number of flashes.....	19

O

ON/OFF button.....	12
--------------------	----

P

Power zoom function.....	40
Programmed auto (P).....	24

R

REMOTE.....	58
Ready-light.....	20, 29
Rear-curtain sync.....	47
Red-eye reduction control.....	46
Red-eye reduction with slow-sync flash.....	46
Remote flash unit.....	58
Reset.....	13

S

Shutter-priority auto exposure (S).....	25
Slow-sync flash mode.....	46
Soft Case.....	6
Sound monitor.....	67
Speedlight Stand.....	61
Speedlight parts and their functions.....	10
Standard TTL flash.....	33
Standby function.....	21
Supplied accessories.....	6

T

TTL mode.....	33
Test firing.....	20

U

Underexposure value in the TTL auto flash mode.....	29
--	----

W

Wide-Area AF-Assist Illuminator.....	5, 51
Wireless master flash unit.....	58
Wireless multiple flash shooting.....	58
Wireless remote flash unit.....	62

Z

Zoom-head position.....	40
-------------------------	----

Nikon

No reproduction in any form of this manual, in whole or in part (except for brief quotation in critical articles or reviews), may be made without written authorization from NIKON CORPORATION.